

AD5X User Guide

≡ 用户使用手册 ≡

**⚠ WARNING
注意事项**

-
1. Please refer to this Guide for initial printer setup.
 2. Hot! Avoid touching the heating nozzle in operation.
 3. Moving parts in the printer may cause injuries. Do not wear gloves or other sources of entanglement in operation.
1. 请参照本指南完成打印机的初始准备。
 2. 高温危险！打印机喷嘴在工作时会被加热，操作时请避免接触！
 3. 可动部件可能会造成卷入挤压和切割伤害。操作机器时请不要佩戴手套或缠绕物。
-

**⚠ Safety Notice
安全提示**

Do not power on the printer until installation is completed.
请勿在打印机安装完成之前通电。



For more product information, please visit our official website.
www.flashforge.com - [Support]

CONTENTS

Notice	02
1. Equipment Introduction	04
1.1 Printer Components	04
1.2 Printer Parameters	05
2. Software Introduction	06
2.1 Flash Studio Mobile Instructions	06
2.2 Slicing Software Instructions	07
3. Load and Configure Filaments for IFS	11
4. Unload/Change Filament	13
5. Network Connection	13
5.1 Wireless Network Connection	13
5.2 Wired Network Connection	14
6. Print	15
6.1 Print via Wi-Fi Transfer	15
6.2 Print via USB	17
6.3 Model Removal After Printing	19
7. Introduction to Auxiliary Functions	19
7.1 Leveling and Calibration	19
7.2 Other Functions	20
8. Maintenance	21
8.1 Suggestions on Platform Plate Usage	21
8.2 Suggestions on Nozzle Usage	21
8.3 General Maintenance	21
9. Q&A	22
10. Help and Support	26

NOTICE

SAFETY NOTICE: PLEASE CAREFULLY READ AND STRICTLY FOLLOW ALL THE SAFETY WARNINGS AND NOTICES BELOW ALL THE TIME.

Note: Each 3D printer undergoes printing tests before leaving the factory. Filament residue on the nozzle or slight scratches on the build plate are normal and do not affect usage.

WORK ENVIRONMENT SAFETY

- ◆ Please keep the workspace clean and tidy.
- ◆ Please ensure the equipment operates away from combustible gases, liquids, and dust. High temperatures generated during operation may react with combustible gases, liquids, or airborne dust, potentially causing fires.
- ◆ Children and untrained individuals should not operate the equipment alone.

ELECTRICAL SAFETY

- ◆ Please properly ground the equipment. Do not modify the plug. Ungrounded equipment/improperly grounded equipment/modified plug will inevitably increase the risk of electric leakage.
- ◆ Avoid exposing the equipment to damp or direct sunlight environments. Humidity will increase the risk of electric leakage. Exposure to sunlight will accelerate the aging of plastic parts.
- ◆ Make sure to only use the power cord provided by Flashforge.
- ◆ Do not use the equipment during thunderstorms.
- ◆ Please turn off the equipment and unplug it if it is not in use for a long time.

PERSONAL SAFETY

- ◆ Do not touch the extruder, build plate, etc., during printing.
- ◆ Do not touch the extruder and build plate after finishing printing to avoid high temperature burns or mechanical damage.
- ◆ Do not wear scarves, masks, gloves, jewelry, or other objects that can easily get tangled into the equipment while operating it.
- ◆ Do not operate the equipment while you are tired or under the influence of drugs, alcohol or medication.

CAUTIONS

- ◆ Keep the inside of the equipment clean. Do not drop metal objects into the grooves at the bottom of the build plate.
- ◆ Please clean up filament debris in time. It is recommended to operate this outside the equipment.
- ◆ Any modification of the equipment by yourself will void the warranty.
- ◆ Please keep the distance between the extruder and build plate for at least 50mm during filament loading. Too-close distance may cause nozzle clogs.
- ◆ Please operate the equipment in a well-ventilated environment.
- ◆ Do not use the equipment for illegal activities.
- ◆ Do not use the equipment to make food storage containers.
- ◆ Do not place printed models into your mouth.

EQUIPMENT ENVIRONMENT REQUIREMENTS

- ◆ Room temperature: 15-30°C; Humidity: 20-70RH%

EQUIPMENT PLACEMENT REQUIREMENTS

- ◆ The equipment must be placed in a dry and well-ventilated environment. A distance of at least 20cm must be reserved around the front, back, left and right sides of the equipment. Recommended storage temperature: 0-40°C

COMPATIBLE FILAMENT REQUIREMENTS

- ◆ When using this equipment, it's recommended to use Flashforge's filaments. If non-Flashforge filaments are used, there will be certain differences in material properties, and print parameters may need adjustments.

FILAMENT STORAGE REQUIREMENTS

- ◆ Please store filaments in a dry and dust-free environment after unpacking. It is recommended to use the matching filament dry box for storage.

LEGAL STATEMENT

- ◆ Users are not authorized to make any modifications to this User Guide.
- ◆ Flashforge shall not be held responsible for any safety incidents resulting from the disassembly or modification of the equipment by the customer. No one is allowed to modify or translate this Guide without Flashforge's permission. This Guide is protected by copyright, and Flashforge reserves the right of the final interpretation of this Guide.
- ◆ First Edition (October 2024)
Copyright © 2024 Zhejiang Flashforge 3D Technology Co., Ltd. All Rights Reserved.

1. Equipment Introduction

1.1 Printer Components

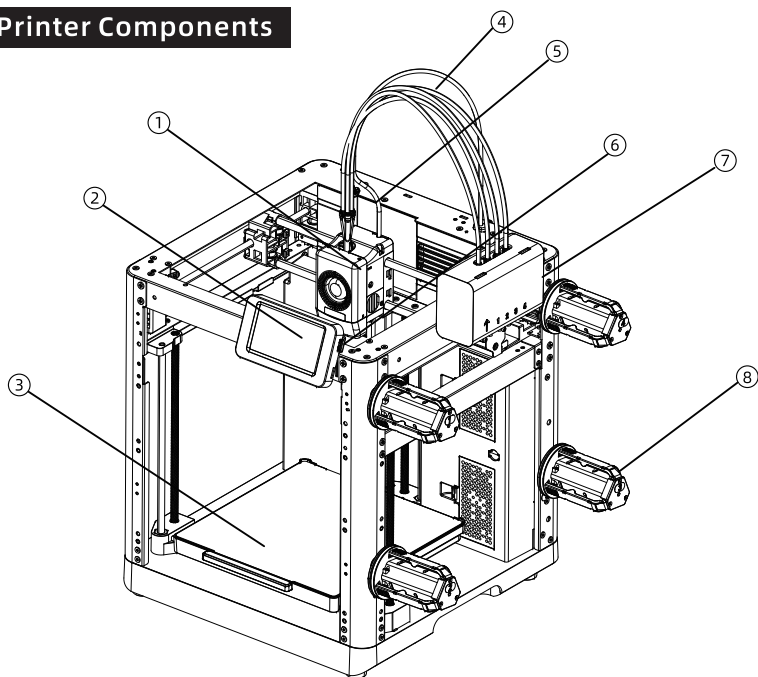

1. Extruder
2. Display Screen
3. Build Plate
4. 4-in-1 Guide Tube
5. Extruder Cable
6. USB Port
7. IFS Module
8. Spool Holder
9. Cable Clip
10. IFS Connection Cable
11. Waste Outlet
12. Ethernet Port
13. Power Switch
14. Power Port

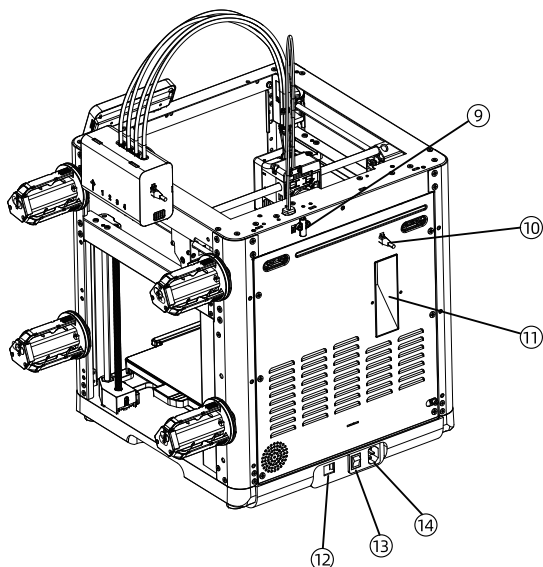

1.2 Printer Parameters

Device Name	AD5X
Extruder Quantity	1
Printing Precision	±0.1mm (testing based on 100mm cubes)
Positioning Accuracy	X/Y-axis: 0.0125mm, Z-axis: 0.0025mm
Layer Thickness	0.1-0.4mm
Build Volume	220 x 220 x 220mm
Nozzle Diameter	0.4mm (default), 0.25/0.6/0.8mm (optional)
Printing Speed	10-300mm/s
Max Acceleration	20000mm/s ²
Max Travel Speed	600mm/s
Max Extruder Temp	300°C
Power Supply	Input: AC 100~120V/200~240V, 50/60Hz, 650W
Device Dimensions	363 x 363 x 413mm (excluding the display screen and spool holder) 363 x 402 x 448mm (including the display screen, excluding the spool holder)
Net Weight	11.4kg
Connectivity	USB/Wi-Fi/Ethernet
Operating Temp	15-30°C
Compatible Operating System	Windows 7/8/10/11; Mac OS: support version 10.9 or later
Slicing Software	Flash Studio Desktop/OrcaSlicer
Max Bed Temp	110°C
Leveling Method	One-click auto leveling
Filament Run-out Reminder	√
Power Loss Recovery	√
Smart Touch Screen	4.3-inch
Build Plate	PEI steel sheet

2. Software Introduction

2.1 Flash Studio Mobile Instructions

1. Download Flash Studio Mobile by scanning the QR code (see right) or from the app store, register your Flashforge account, and log in.



2. Click [⚙️] - [📶], and then turn on the Wi-Fi switch to connect to the network.

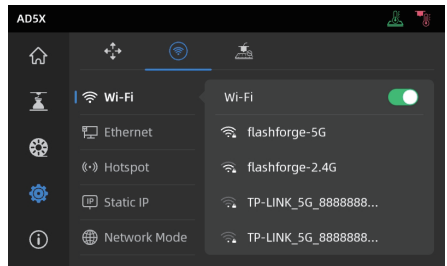

3. Click [ⓘ] to enter the information interface, and then click [My Account] to access the printer's QR code.

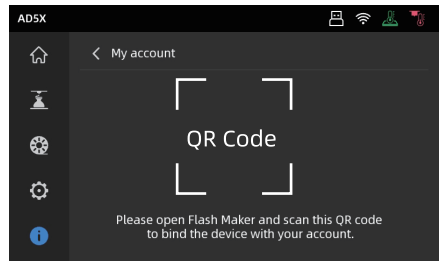
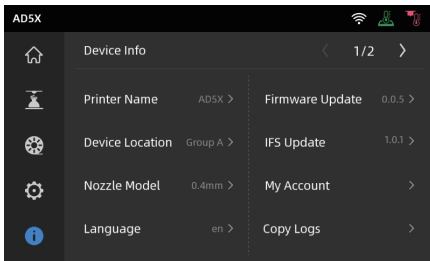

Note

- ◆ By default, the device name is set to "AD5X", and its location is set to "Group A" upon factory settings.
- ◆ You can modify the name and location on the printer's information interface as needed.
- ◆ Real-time monitoring is only available if a camera is installed and the feature is enabled.
- ◆ The APP does not support connection in the LAN Only mode.

4. Use Flash Studio Mobile to scan the QR code on the printer screen to bind the printer to your account.

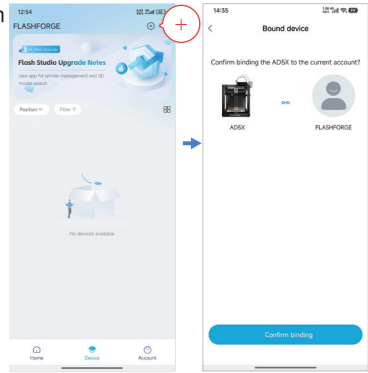

2.2 Slicing Software Instructions

Note Before reading the brief instructions, please ensure you have reviewed the Quick Start Guide and completed the first print.

Before printing 3D model files, you need to configure slicing presets for the corresponding printer. Recommended slicing software: **Flash Studio Desktop**.

Pre-printing Steps:



Flash Studio Desktop

* The steps are illustrated for one machine type.

Flash Studio Desktop allows you to log in with your Flashforge account, bind your device, and remotely send files and monitor your device.

Download Instructions

Flash Studio Desktop
Download Flash Studio Desktop from:
<https://flashforge.com/blogs/download-software/software>.

Or scan here to download:



1. Open the installed Flash Studio Desktop.



2. Setup Wizard:

Follow the setup wizard prompts for selecting your region, machine type, and materials.
(Note: You can select all machine types and material types in the list for later slicing options.)

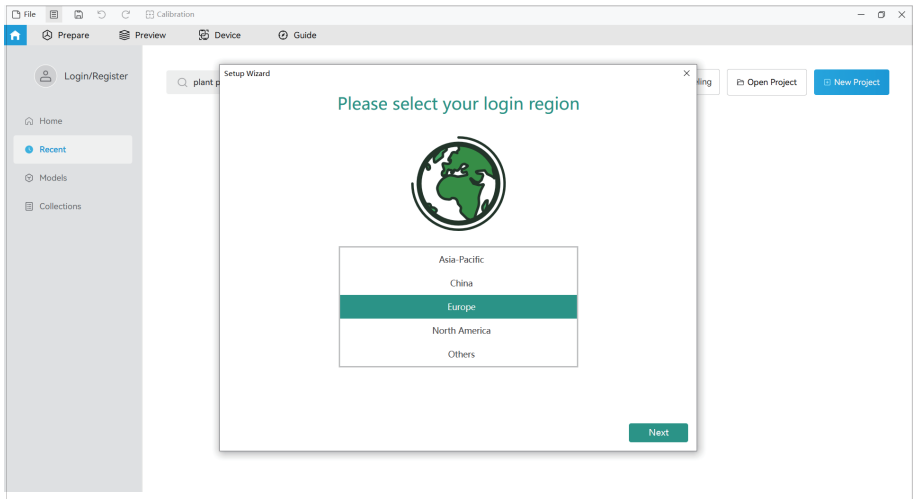

3. Account Login/Register:

Login to Flash Studio Desktop using your Flashforge account. If you don't have an account, register one using your mobile phone number. (Note: Flash Studio Mobile and Flash Studio Desktop share the same account.)

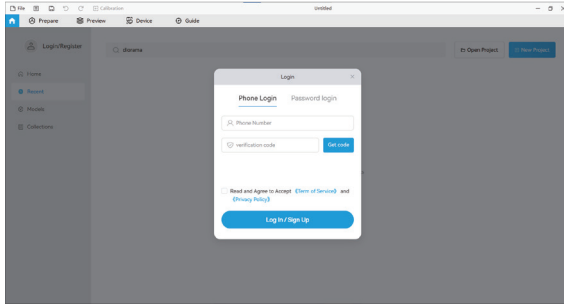

4. Create or open a project for slicing. You can select the machine type, material, and recommended parameters in the printer, filament, and process bars. Select the printer as AD5X. If fewer than four filaments are shown, manually add them until there are four before importing your model.

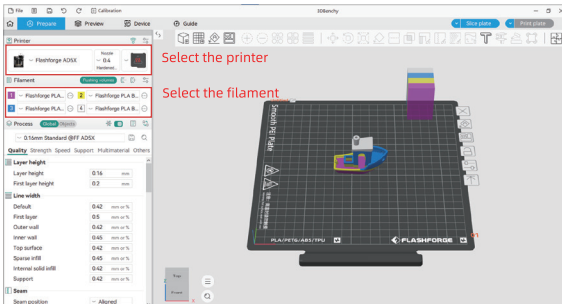

5. After slicing, select the printer and send for printing.

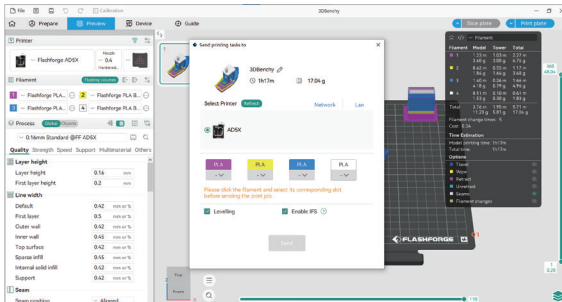



Note

For multi-color printing, filament information needs to be configured manually. Click the corresponding channel and select the filament in the matching or similar color. (Once the IFS information is configured on the device, the slicing software can retrieve the IFS information from that device, as shown below:)

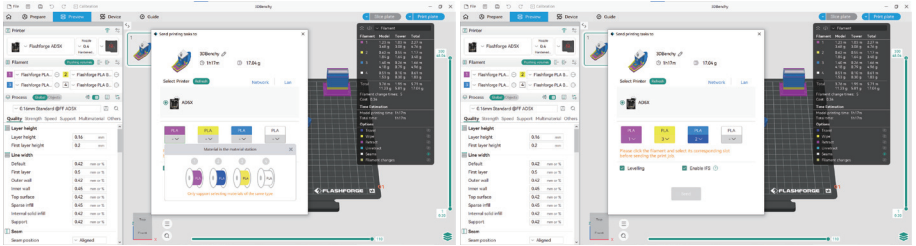

6. You can remotely monitor the printing progress and pause/stop printing when necessary on the device interface. (Note: Real-time monitoring is only available with a camera installed and activated. AD5X does not come with a camera by default.)

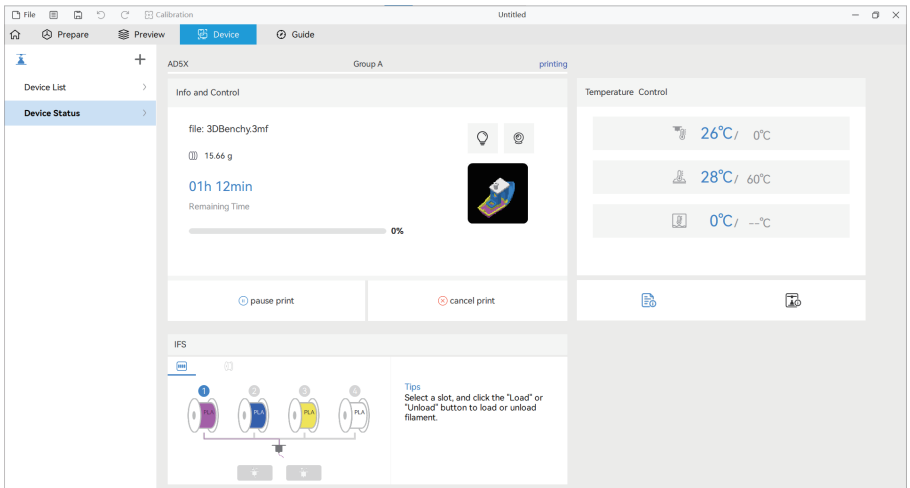

Tip:

For details and tutorials on software usage, please refer to Flashforge Wiki. (<https://wiki.flashforge.com/en/home>)

3. Load and Configure Filaments for IFS

Note

Please use the dedicated filament spool holders with the IFS module. These holders feature a reverse rewinding mechanism to prevent tangling. Please make sure the installed spool holder number, the installation position number, and the configured IFS channel number are consistent. Install as shown below.

There are numbered labels that correspond to the numbers on the printer for proper installation.

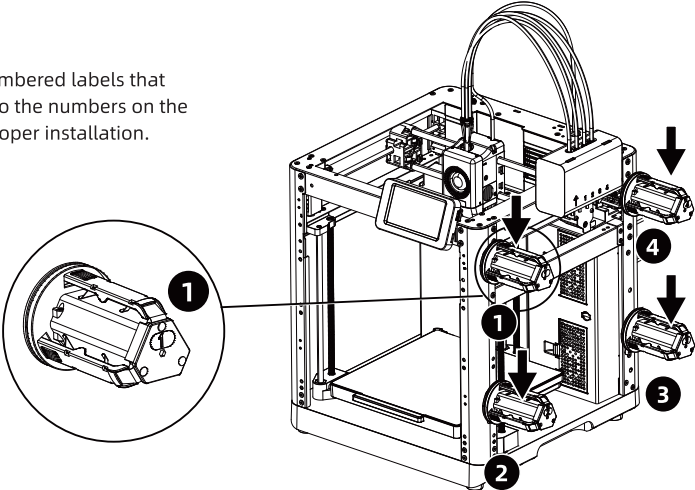

1. Load filaments following the direction shown below.

When loading filaments, insert the four filaments into the 1/2/3/4 inlets, respectively. Thread them through the feed roller, and the device will detect the filaments and automatically feed them into the guide tubes one by one. Once all filaments have reached the tube inlet, the feeding process is completed. With IFS, you can start printing immediately after completing this loading process.

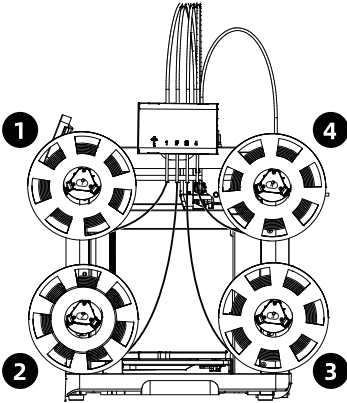

2. After loading the filaments, please manually configure the filament information. Click on the corresponding filament channel, and then click [] to select the corresponding filament type and color. Click [OK].

Note: The device can only print if the filament type of the sliced file matches the configured (actually loaded) filament type.

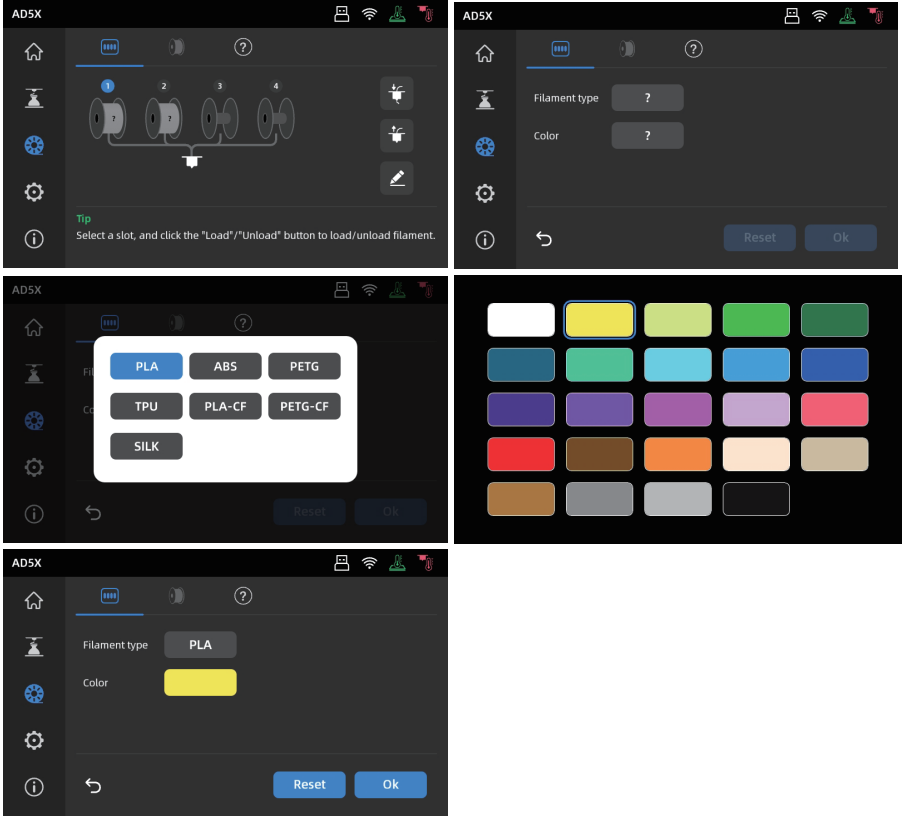



 **Note**

***Expanded Filament Loading:**

When IFS is not in use (**note: single filament mode can only be used when the IFS signal cable is disconnected; when the IFS signal cable is connected, the device will load filament in the IFS mode by default**), users can click on the filament and select the loading button on the screen to load it (the operation is the same as with IFS).

***This device uses IFS mode for filament loading by default.**

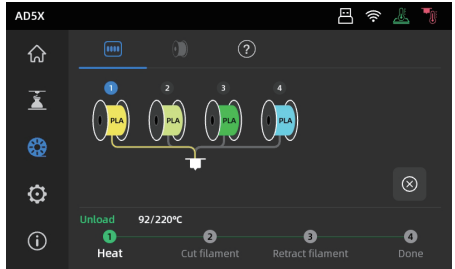
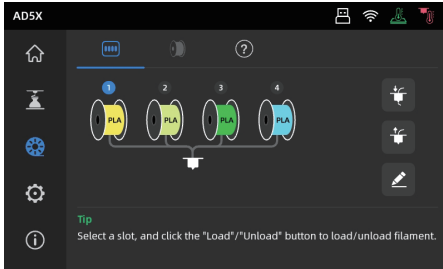

4. Unload/Change Filament

1. If the filament has not entered the extruder feed roller, you can manually pull it out.
2. If the current filament is still inside the extruder, click [] - []. The filament will retract to the top of the guide tube. Once it has retracted from the extruder, you can manually pull it out.



5. Network Connection

5.1 Wireless Network Connection

1. Click [] - [] to enter the network connection interface.

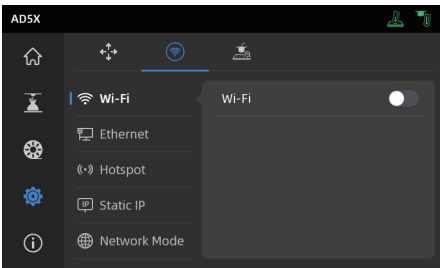

2. Turn on the Wi-Fi switch, and tap to connect to the corresponding wireless network. Once connected successfully, the network will be marked, and an [Wi-Fi] icon will appear at the top right corner of the screen.

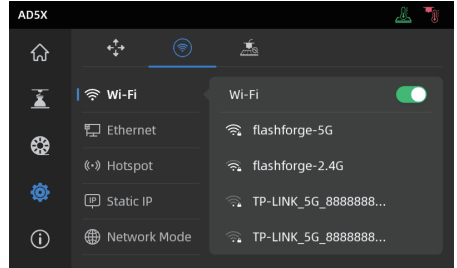
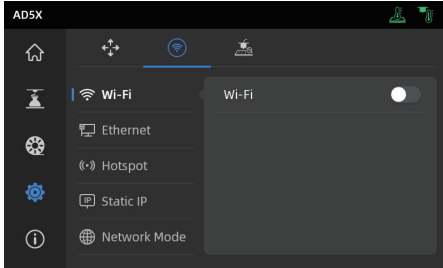

5.2 Wired Network Connection

1. Select [Ethernet] and plug the network cable into the Ethernet port on the back of the printer following on-screen instructions.
2. Once connected successfully, it will display as [Connected], and an [Ethernet] icon will appear at the top right corner of the screen.

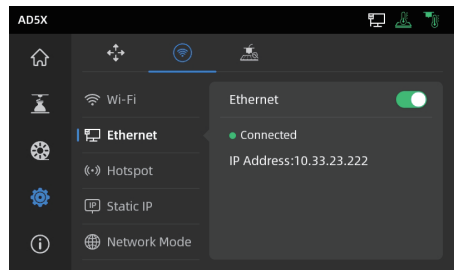
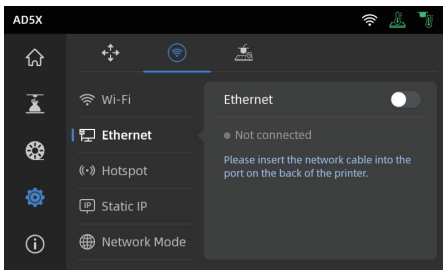

6. Print

6.1 Print via Wi-Fi Transfer

After successfully connecting the printer to the network, open Flash Studio Desktop. After finishing slicing, click [Print plate] in the menu, and select the connected AD5X to send the print job. Before transferring the file, please connect the printer to a network (either wireless or wired) and bind the printer to the slicing software. The printer and the computer must be connected to the same LAN. There are two modes for printer connection: WAN Mode and LAN Only Mode.

1. WAN Mode: Please log in/register your Flashforge account before connecting the printer. If the device has already been bound and connected via the mobile app, the connected device will be automatically displayed after you log in to the account in the slicing software. If the mobile app is not connected, you can click [+] on the device page to open the search list and select the desired device to connect.

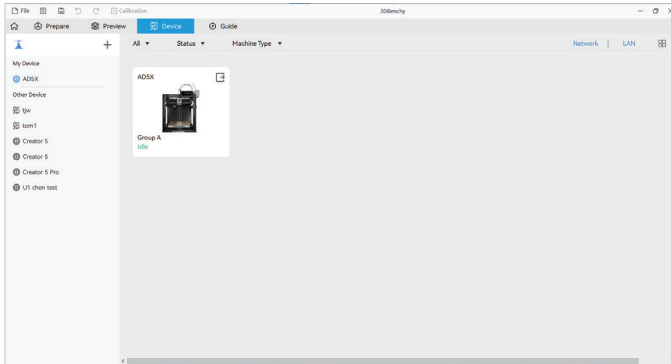

2. LAN Only Mode: Enable [LAN Only] via [Network Mode]. In the slicing software, click [+] on the device page to find the corresponding printer. Select the printer and enter the Printer ID displayed on the printer to complete the connection.

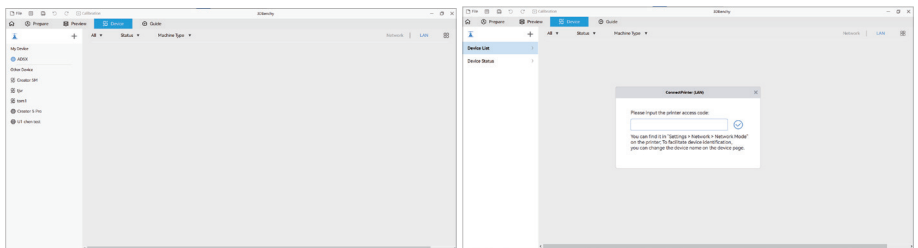

3. After connecting the printer to the slicing software, you can click [Print plate] after slicing, select the corresponding printer, and then click [Send].

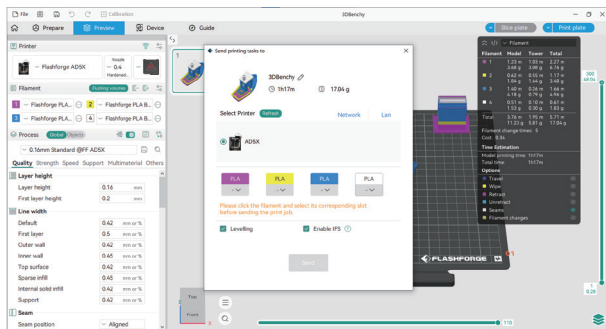

Note

For multi-color printing, filament information needs to be configured manually. Click the corresponding channel and select the filament in the matching or similar color. (Once the IFS information is configured on the device, the slicing software can retrieve the IFS information from that device, as shown below:)

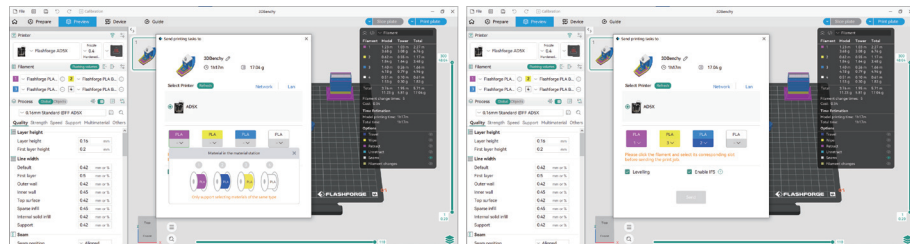

Note

The numbers embedded before each color in the Filament bar are just the order numbers for filaments and are not related to the IFS channel numbers.

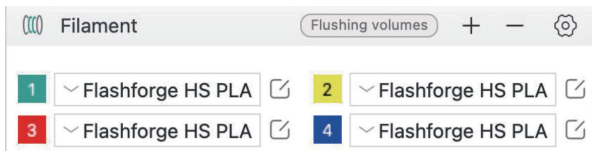

- Before sending the print job, please confirm in the pop-up window that each selected channel for the colors matches your needs. If the channel info shows "?", it indicates that the filament on the device has not been configured. If the channel info is blank, it means that no filament is installed in that channel on the device. (Please ensure that the filament in that slot matches the filament configured in the sliced file.)

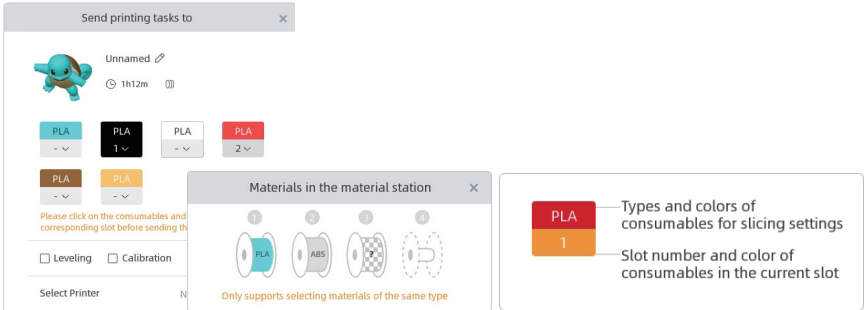

6.2 Print via USB

- In the slicing software, select [Export plate sliced file]. This will save the sliced file in the 3MF format. Save this file to a USB flash drive, insert the USB flash drive into your printer, and select the corresponding file to print.

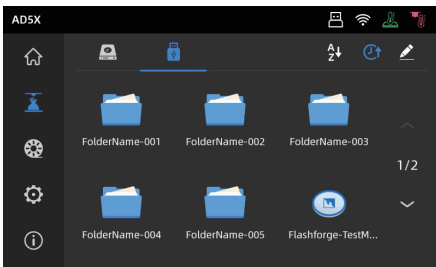

- Click [Next] to configure IFS channels. You can manually change the filament options to match your actual printing needs. On the screen, you can manually select the channel for each color.

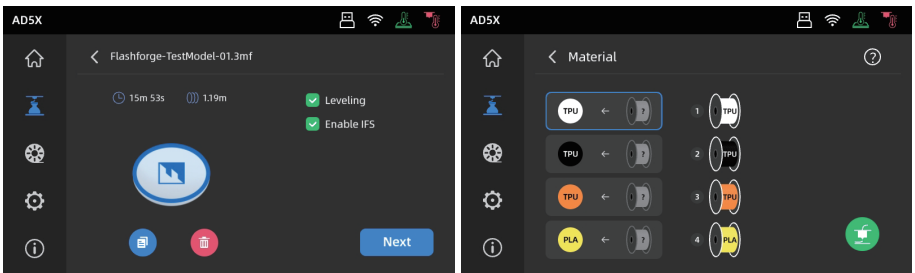

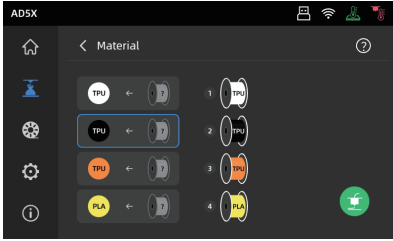

3. Click the box on the left, and then select the desired filament channel from the right. You can select a channel multiple times. If no filament matches the color specified in the file, you can either place the specified filament in the IFS channel or select a filament with similar properties and a close color match. After configuring the channels, you can click to print. If the filament selected during slicing does not match the type of filament on the IFS, you will not be able to select that filament for printing. For example, as shown below, for a print file sliced with PLA, you can select channels 2 or 3 with PLA for printing, but channel 4 with ABS cannot be selected.

⚠ Note

If the file imported to the USB flash drive is in G-code format, the channel cannot be manually modified. Only 3MF files support further modifications.

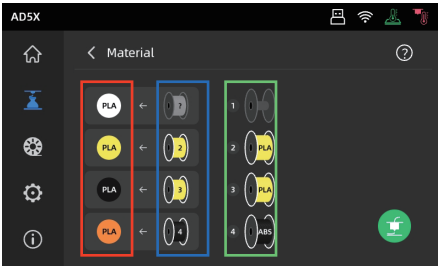

*Explanation:
 Red box (left): Here displays the filament type and color configured in the slicing software.
 Blue box (middle): Users can click to manually modify the corresponding installed filament spool. After selecting this column, click on the corresponding filament loaded in the actual channel in the green box. Once selected, it will be mapped to the print material.
 Green box (right): Here displays information of the actual loaded filament on the device.

4. You can refer to the [Guide] for the mapping between them.

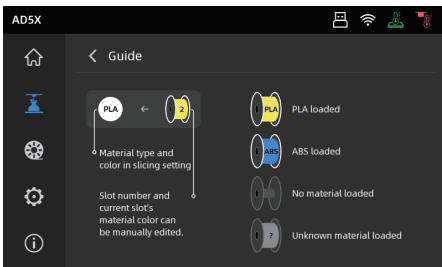

6.3 Model Removal After Printing

⚠ Note When printing is completed, the nozzle and build plate may still be at a high temperature. It is recommended to allow them to cool down before removing the model.

After printing is completed, directly take out the flexible steel plate and bend the platform to remove the model. Ensure there is no residual filament on the platform before the next print.

Tips on Model Removal:

1. Please take the platform plate outside the printer for model removal to prevent model debris from accumulating inside the printer. It's recommended to keep the chamber clean.
2. For models printed with TPU or other flexible materials, it is recommended to use a scraper for removal, which ensures you can remove the flexible model from the bed without causing damage.

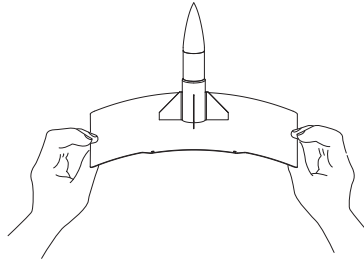

7. Introduction to Auxiliary Functions

⚠ Note The interface layout may change whenever there is an upgrade of firmware.

7.1 Leveling and Calibration

During the first startup, equipment calibration will be performed. During subsequent use, choose leveling or vibration compensation as needed.



When to perform leveling:

- ◆ If continuously printing with PLA material, perform automatic leveling once with no need to do so before each print. However, performing leveling can inevitably improve the printing success rate;
- ◆ When switching between different materials (e.g., from PLA to ABS), please perform leveling before each print;
- ◆ If the platform-nozzle distance is too far (poor adhesion) or too close (no filament extrusion), please perform automatic leveling;
- ◆ After replacing the build plate or nozzle, please perform automatic leveling. Be sure to perform leveling after nozzle change to avoid the risk of damaging the extruder.

When to perform vibration compensation:

- ◆ When there is noticeable ghosting and ringing on 3D prints;
- ◆ After adjusting the tension of the synchronous belt;
- ◆ When the printer has been unused for a long time and is now being restarted.

Instructions:

Click [] - [] to enter the leveling and calibration interface. Choose [Leveling] or [Vibration compensation], click [Start], and the printer will automatically perform the corresponding operation. (Note: Before calibration, ensure there are no foreign objects on the platform or at the nozzle tip.)

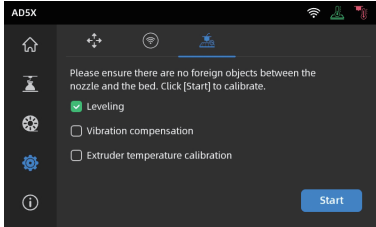

Note on when to perform PID calibration: This can be performed after replacing the nozzle or when the nozzle temperature is abnormal.

7.2 Other Functions

- ◆ In the device info interface, you can enable or disable sound and filament detection, and perform firmware updates. When [Filament Detection] is enabled, the printer will stop printing if filament runs out mid-print.
- ◆ When connected to a wireless network, click [Firmware Update] to view the current version, check for updates, and perform online firmware updates.
- ◆ Printer Name and Location: Users can customize the name and location as desired for easier management. Modifying the location can help users manage their devices for better organization. Users can also assign groups (A/B/C), which will be displayed in both the app and slicing software, allowing for easy filtering.

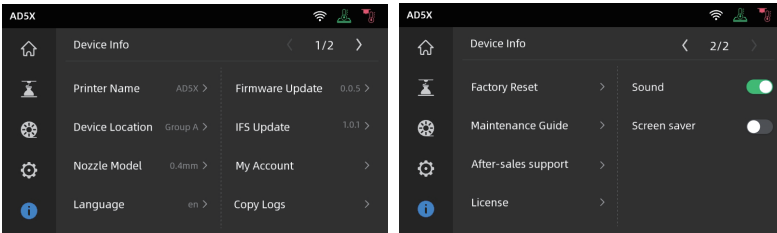

- ◆ Power Loss Recovery. After a power outage, the printer will display a pop-up prompt when power is restored. If you select [Yes], the printer will resume printing the unfinished model.

8. Maintenance

8.1 Suggestions on Platform Plate Usage

1. Powder coated PEI plate requires glue and is suitable for printing PLA/PETG/PLA-CF/PETG-CF/ABS/ASA. TPU printing does not require glue. This plate comes with the printer.
2. PEI film plate is suitable for printing PLA/TPU without glue. For PETG, it's recommended to use glue. This plate can be purchased separately.
3. PC sticker platform plate is suitable for printing PC/ABS/ASA. This plate can be purchased separately.
4. After applying glue to the platform plate, it can be cleaned with water.
5. If the platform plate gets oily, it can be cleaned with a dish detergent.
6. If the platform plate deforms significantly after long-term use, it's recommended to replace it with a new one.

8.2 Suggestions on Nozzle Usage

1. Please use one nozzle for the same type of material to avoid clogs and extend nozzle lifespan, especially when working with fiber-reinforced materials and PETG. Please avoid mixing them with other materials.
2. When switching to a different material with the same nozzle, if the new material's printing temperature is lower, adjust the setting to a higher temperature for filament extrusion to purge old filament from the nozzle.
3. When switching to a different material with a higher printing temperature, just load the new filament.
4. To clean residual filament inside the nozzle, you can perform multiple filament loading or manually clear any remaining filament using the unclogging pin tool.
5. After replacing the nozzle, please perform leveling again.

8.3 General Maintenance

1. After every 1,000 hours of printing, please perform maintenance on key components: Wipe the X, Y, and Z-axis linear shafts clean with a dust-free cloth or paper.
 2. After cleaning the Z-axis lead screw, please apply the provided or a suitable lubricant evenly.
 3. To prevent filament from absorbing moisture, breaking, or causing issues with the guide tube, please unload the filament from the printer and store it in a sealed, moisture-proof container if the printer will be idle for more than two days.
 4. Please promptly clear any filament or foreign objects from the lead screw.
- For detailed maintenance instructions, please refer to Flashforge Wiki.

9. Q&A

Q1. What to do if the nozzle is clogged?

Troubleshooting Step 1: Manually press the handle at the extruder, cut off the filament, then remove the guide tube and check if the filament tip is flat. If not, trim it to be flat, reinsert the guide tube and filament into the extruder, and then click for loading to check.

Troubleshooting Step 2: Remove the extruder and check if the filament is blocked inside it.

Q2. How to replace the nozzle?

If there's filament inside the nozzle, please unload it first or manually cut it off. Then follow these steps:

1. Remove the extruder's front cover.

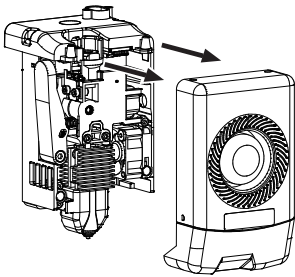

2. Remove the nozzle silicone sock.

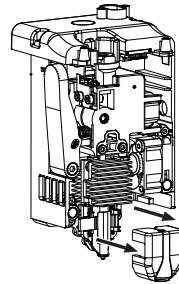

3. Release the heatsink and nozzle clip.

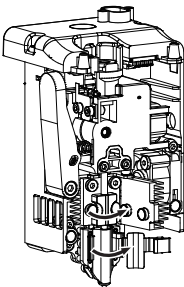

4. Remove the nozzle.

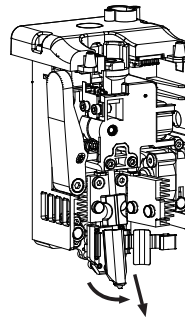

5. Install the new nozzle (0.4mm).

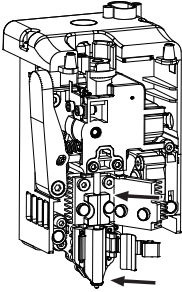

6. Secure the heatsink and nozzle clip.

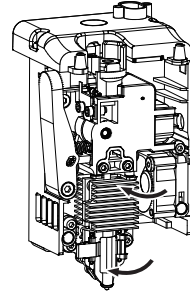

7. Reinstall the nozzle silicone sock.

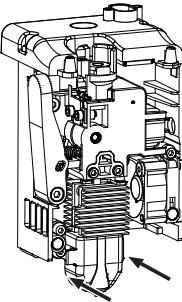

8. Reinstall the extruder's front cover.

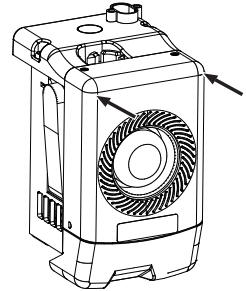

When reinstalling the nozzle, ensure it is properly aligned and securely fastened. Install the silicone sleeve back into place. After replacing the nozzle, it's crucial to perform a nozzle temperature calibration and bed leveling.

Q3. Is leveling/calibration required after replacing the nozzle?

Yes. It is recommended to perform automatic leveling to ensure high print quality as slight errors may occur during nozzle installation. The device will have leveling enabled by default before each print. A temperature calibration for the new nozzle is also required.

Q4. What to do if the extruder moves but no filament comes out at the beginning of printing after starting the print?

1. Observe the filament guide tube to check if filament has entered the nozzle. If not, please click the loading button until filament comes out.
2. Check if the nozzle is clogged. If so, please refer to the solution of Q1.

Q5. What to do if the nozzle position is too high (far from the bed) or too low (hitting the bed) during printing? How to adjust it?

Please check if the bed is properly installed and there is no excessive residue on the nozzle. If these issues exist, address them first. Then, go to the settings interface, select the leveling option, and perform automatic leveling or enable automatic leveling before printing. If the problem persists and your entire print is coming out poorly because the nozzle is too close or too far from the bed, you can adjust the Z-axis offset by clicking []. If the bed is too far, click the up arrow. If the bed is too close, click the down arrow.

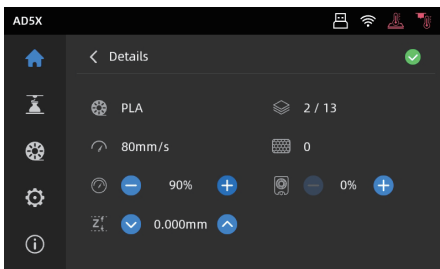
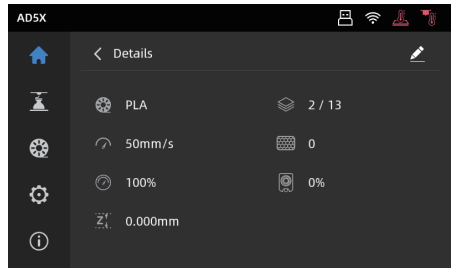
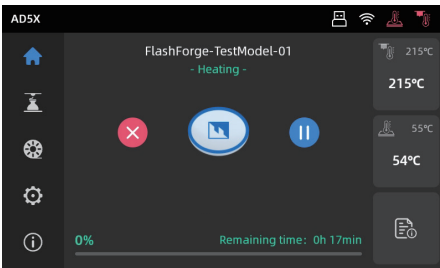

Q6. Can filaments from other brands be used?

Yes. You can use filaments from other brands, but certain parameter adjustments are required due to slight temperature differences in different filaments.

Q7. What to do if your print is warping or not adhering well?

Solution 1: Increase the bed temperature to improve adhesion between the bed and your print.

Solution 2: Add a brim when slicing your model.

Solution 3: Apply glue.

Solution 4: Clean the bed to remove any grease or residue.

Solution 5: Check if the bed is level. The leveling and calibration function can be used.

Q8. What to do if print files can not be found and the screen displays only folders after inserting the USB flash drive?

The USB flash drive format may be incorrect. The device supports the FAT32 file system. Please format the USB flash drive to FAT32.

Q9. What to do with the Wi-Fi connection failure?

1. Please check if the Wi-Fi name contains special characters. If so, modify it and try again.

2. Please check if the password contains special characters. If so, modify it and try again.

Q10. What to keep in mind during a firmware update?

Do not power off the printer or disconnect from the network during firmware download or update to prevent update failures.

Q11. Why is the screen blank on startup?

If the startup sound can be heard, please replace the screen or the cable. If not, please contact customer support.

10. Help and Support

Flashforge's professional after-sales service personnel and salesmen are on standby for you at any time and are ready to help you with any problem you may have with the printer. If the issues or questions are not covered in this User Guide, you can seek for solutions on our official website or contact us by phone.

There are instructions and solutions to common issues that can be found on our official website. Many questions are answered at Flashforge's English official website - www.flashforge.com.

Flashforge customer support team can be reached by phone from 8:00 AM to 5:00 PM, from Monday to Saturday. In case you contact us during off-duty time, your inquiry will be answered the next working day immediately. We apologize for any inconvenience this may cause.



Note

Changing different filaments may leave minor impurities in the nozzle, leading to clogs. As this can be solved by just unclogging it, it's not owing to a quality issue. If you encounter this problem during use, please contact customer support and follow their guidance for unclogging.

After-sales Service Tel: 400-886-6023

E-mail: support@flashforge.com

Address: Floors 2-4, Building B, Huaxing Development Building, No.328 Wen'er Road, Xihu District, Hangzhou City, Zhejiang Province, China

Note: Please provide the product serial number which can be found on the barcode at the back of the printer when contacting customer support.



S/N: FFAD*****

Specifications

2.4G Wi-Fi Frequency Range: 2412MHz~2472MHz (Max EIRP: 15.22dBm)

5.2G Wi-Fi Frequency Range: 5150MHz~5250MHz (Max EIRP: 11.66dBm)

5.8G Wi-Fi Frequency Range: 5725MHz~5850MHz (Max EIRP: 10.91dBm)

This product can be used across EU member states.

The device is restricted to indoor use only when operating in the 5150MHz~5350MHz WLAN band in the following.

Manufacturer: Zhejiang Flashforge 3D Technology Co., Ltd.

Address: Floor 3, Building 2, No. 1 Jianlang Road, Tangxia Town, Dongguan City, Guangdong Province



更多产品相关资料您可以登陆闪铸官网查看。
www.sz3dp.com - [技术支持]

目录

注意事项	29
第一章 设备简介	31
1.1 - 部件介绍	31
1.2 - 设备参数	32
第二章 软件介绍	33
2.1 - APP应用-Flash Studio Mobile	33
2.2 - 配套切片软件简要	34
第三章 给IFS上料并配置耗材信息	38
第四章 退出/更换耗材	40
第五章 网络连接	40
5.1 - 无线网络连接	40
5.2 - 有线网络连接	41
第六章 打印	42
6.1 - WI-FI传输文件打印	42
6.2 - U盘打印	44
6.3 - 打印后模型移除	46
第七章 打印机其他功能介绍	46
7.1 - 调平校准	46
7.2 - 其他功能设置	47
第八章 维护	48
8.1 - 打印平台板使用建议	48
8.2 - 喷嘴使用建议	48
8.3 - 设备一般维护	48
第九章 Q&A	49
第十章 帮助与支持	53

注意事项

安全提示：请确保认真阅读以下安全提示

注意：每台3D打印机在出厂前都经过打印测试，若设备喷头存在耗材残留或打印平台有轻微划痕，都属正常现象，不影响使用。

工作环境安全

- ◆ 请确保设备的工作台面干净整洁。
- ◆ 请确保设备工作时远离可燃性气体、液体及灰尘。设备运行产生的高温有可能会与可燃性气体、液体及空气中的粉尘发生反应从而引发火灾。
- ◆ 儿童及未经培训的人员请勿单独操作设备。

用电操作安全

- ◆ 请务必将设备接地，切勿改装设备的插头。未接地/未正确接地/改装插头必然会增加漏电风险。
- ◆ 请勿将设备暴露在潮湿或暴晒的环境中：潮湿的环境会增加漏电的风险，暴晒会加速设备的塑件老化。
- ◆ 请勿滥用电源线，务必使用闪铸集团提供的电源线。
- ◆ 切勿在雷雨天气使用设备。
- ◆ 如长时间不使用设备，请关闭设备并拔下电源线插头。

个人操作安全

- ◆ 在设备运行时，请勿触碰喷头、平台等位置！
- ◆ 在打印完成时，请勿触碰喷头、平台，以免高温烫伤或机械损伤！
- ◆ 在操作设备时，请勿穿戴围巾、口罩、手套、珠宝装饰等容易卷入设备的物件！
- ◆ 请勿在饮酒、服药之后操作设备！

设备使用提示

- ◆ 保持设备内部整洁，切勿将金属物体掉入打印平台底部的滑槽内。
- ◆ 请及时清理丝料碎屑，建议在设备外进行操作。
- ◆ 自行对该设备进行任何改装将自动失去保修保障。
- ◆ 请在设备进丝操作时，喷头和平台的距离至少保持50mm的距离。距离过近可能会造成喷头堵塞。
- ◆ 请在通风的环境下操作设备。
- ◆ 请勿利用该设备进行违法犯罪的活动。
- ◆ 请勿利用该设备制作食物储存类产品。
- ◆ 请勿将打印模型放入口腔。

设备运行环境要求

- ◆ 室内温度在15-30°C为宜；湿度在20%-70%为宜。

设备放置要求

- ◆ 设备需要被放置于干燥通风的环境中。设备前后左右四周必须预留至少20cm的空间距离。存储温度在0-40°C为宜。

设备兼容耗材要求

- ◆ 在使用该设备时，建议使用闪铸提供或指定的耗材。如使用非闪铸提供耗材，材料特性有所差异，打印参数可能需要调整。

耗材存储要求

- ◆ 耗材拆封后请保持储存环境干燥，无尘，建议配套干燥盒存储。

法律申明

- ◆ 用户无权对此使用手册进行任何修改。
- ◆ 客户若自行拆装或改造设备造成任何安全事故，闪铸集团概不负责。未经闪铸集团允许，任何人不得对该手册进行修改或翻译。本手册受版权保护，闪铸集团对本手册保留最终解释权。
第一版（2024年10月）
- ◆ @Copyright 2024浙江闪铸集团有限公司版权所有

第一章 设备简介

1.1 部件介绍

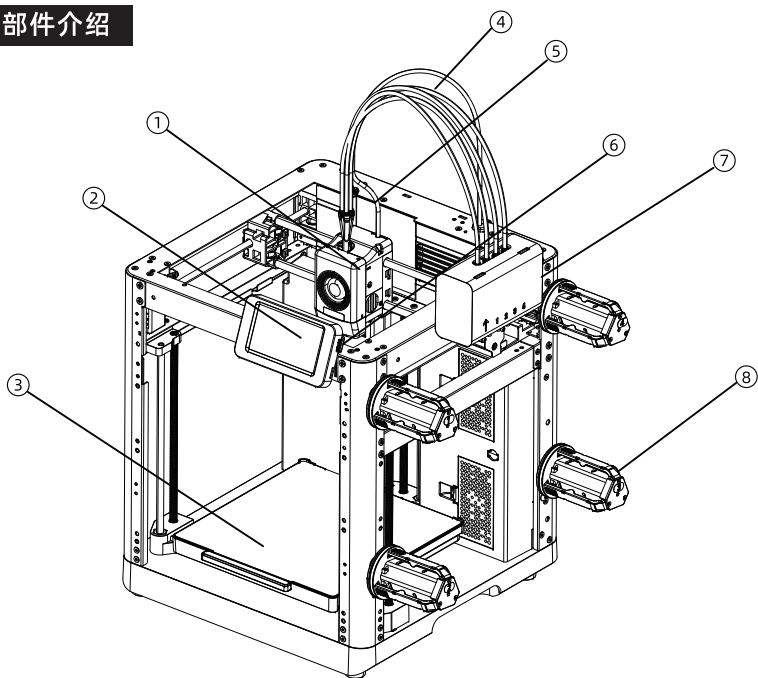

1. 喷头
2. 显示屏
3. 打印平台
4. 四合一导丝管
5. 喷头线
6. USB接口
7. IFS组件
8. 耗材架
9. 压线扣
10. IFS模块连接线
11. 排料口
12. 网线接口
13. 电源开关
14. 电源接口

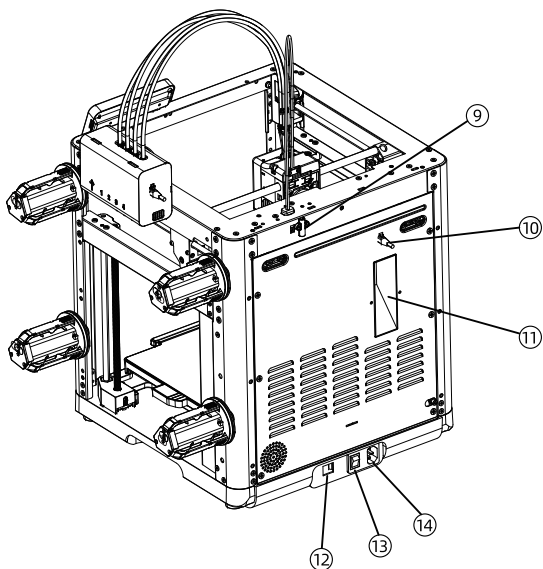

1.2 设备参数

设备名称	AD5X
喷头数量	1
打印精度	±0.1mm [以100mm方块为测试基准]
定位精度	X/Y轴: 0.0125mm, Z轴: 0.0025mm
层厚度	0.1-0.4mm
打印尺寸	220 x 220 x 220mm
喷嘴口径	0.4mm默认[0.6/0.8/0.25mm可选]
打印速度	10-300mm/s
最大加速度	20000mm/s ²
最大移动速度	600mm/s
最高喷头温度	300°C
电源	输入: AC 100~120V/200~240V, 50/60Hz, 650W
设备尺寸	363 x 363 x 413mm [不含显示屏、不含耗材支架] 363 x 402 x 448mm [含显示屏、不含料盘支架]
净重	11.4kg
打印连接方式	USB接口/Wi-Fi/以太网
工作温度	15-30°C
兼容的操作系统	Windows 7/8/10/11; Mac OS支持10.9及以上版本
切片软件	Flash Studio Desktop/OrcaSlicer
平台最高温度	110°C
调平方式	一键自动调平
断丝提醒	√
断电续打	√
智能触控液晶屏	4.3英寸
打印平台	PEI 钢板

第二章 软件介绍

2.1 APP应用-Flash Studio Mobile

1. 扫码(右图)或通过手机应用商城下载 Flash Studio Mobile手机应用, 注册您的闪铸账号并登录。



2. 点击打印机主页【】-【】打开WiFi连接网络。



3. 点击主页【】进入设备信息页, 点击【我的账号】打开打印机二维码。

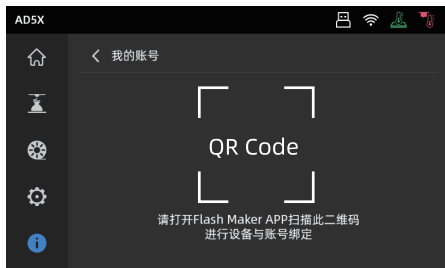

特别提示:

- ◆ 设备出厂时默认设备名称为AD5X, 位置默认为Group A。
- ◆ 您可以根据实际使用情况在打印机【设备信息】界面修改设备名称和位置。
- ◆ 只有安装摄像头并打开该功能才能看到实时监控画面。
- ◆ APP不支持仅局域网模式下连接。

4. 用Flash Studio Mobile手机应用扫描打印机屏幕上的二维码，将打印机与您的账号绑定。

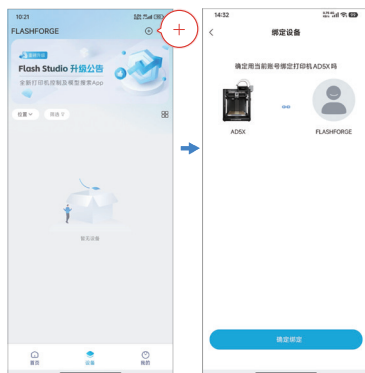

2.2 配套切片软件简要说明

⚠ 注意事项

阅读软件简要说明前，请确认已查看快速启动指南，并已经完成第一次开机打印。

三维模型文件打印前需要先进行对应机器的切片预设才能进行打印。

推荐使用切片软件：**Flash Studio Desktop**。

打印前置步骤为：

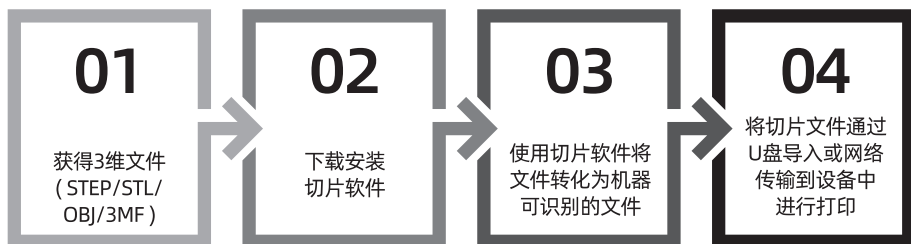

Flash Studio Desktop

* 图中仅用一种机型示意使用步骤讲解

Flash Studio Desktop 可使用您的闪铸账号登陆，可与设备进行绑定，可远程发送文件并监控设备。

下载地址

下载二维码如下：



Flash Studio Desktop 下载地址：
<https://www.sz3dp.com/download-center>。

1. 打开安装好的Flash Studio Desktop软件。



2. 配置向导。

首次使用软件根据配置向导提示选择您所在的登录地区以及对应机型及使用材料。（注：您可以勾选列表中全部机型及材料类型，以便后续在切片中选择。）

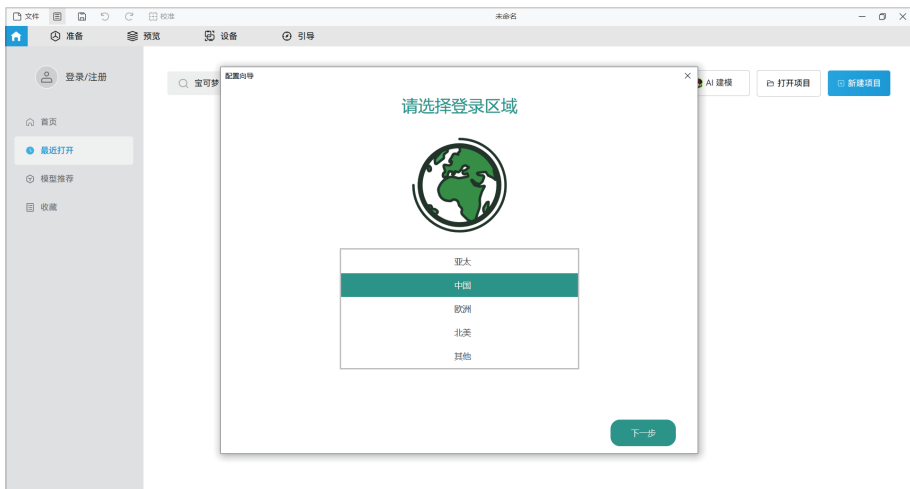

3. 账号登录/注册。

使用您的闪铸账号登录Flash Studio Desktop，如果没有账户，请进行手机注册。
(注：Flash Studio Mobiler和Flash Studio Desktop使用同一账号。)

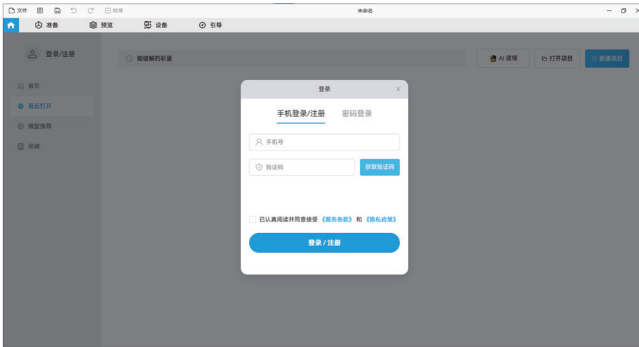

4. 新建或打开一个项目并进行切片，您可以在打印机、耗材丝、工艺的配置栏里选择显示对应机型、材料及推荐参数。机型选择AD5X, 材料配置若显示不足4个,则手动添加到4个,再进行模型导入。

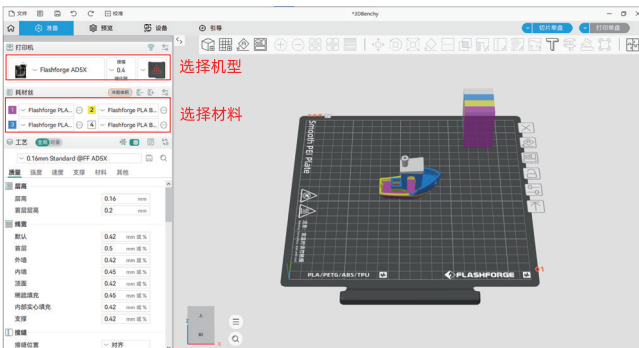

5. 完成切片后，选择打印机并发送打印。

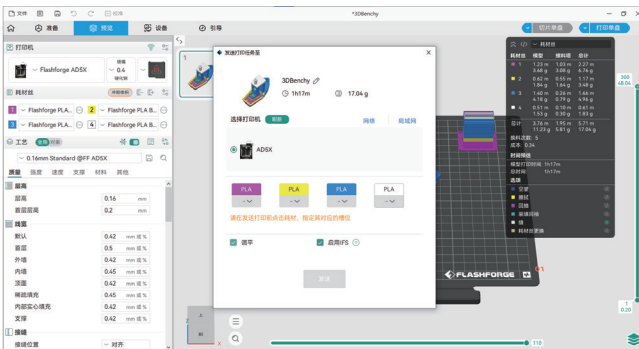



注意事项

多色打印时,需要手动配置材料信息,点击对应通道,选择对应或相似颜色的材料
(当设备端已经配置好IFS 材料信息后,切片软件可读取到该设备对应IFS 的信息。)
如图所示。

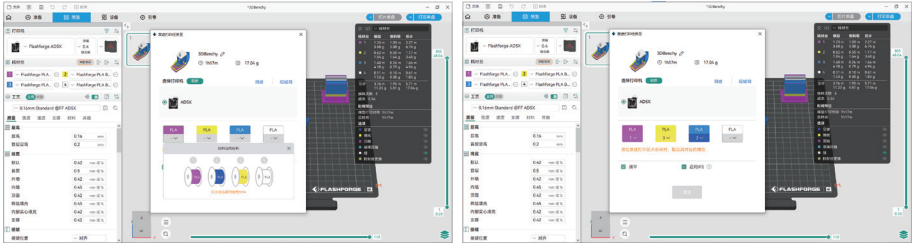

6. 在“设备”界面,对您的打印进程进行远程监控,并可在需要时暂停/停止打印。(注:只有安装并打开摄像头,才可以看到实时监控画面,AD5X出厂默认未装摄像头。)



提示

更多软件相关的详细信息和使用教程请访问闪铸官方Wiki查阅。
(<https://wiki.flashforge.com/en/home>)

第三章 给IFS上料并配置耗材信息

⚠ 注意事项

使用IFS时需配合专用的耗材支架；该耗材架具有反向回卷功能，以防止缠绕；安装支架、安装位置位号、安装IFS材料输入通道三者请按序号一一对应安装。安装方向需如图所示。

内部有数字标贴
对机器上数字对应安装

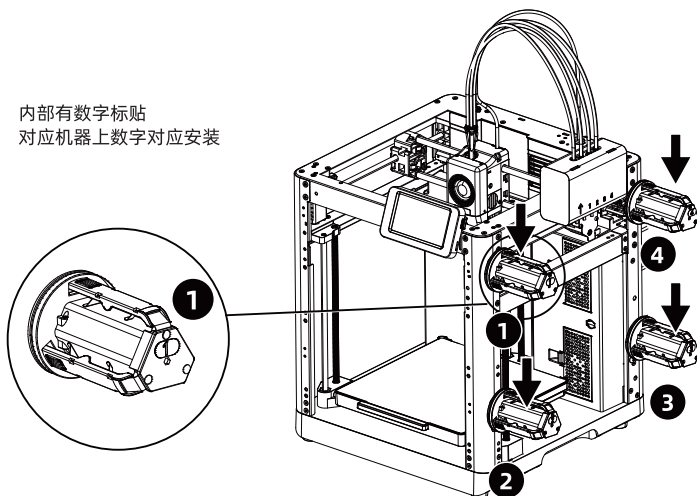

1. 耗材丝料走线方向如下图所示。

耗材进料时将4个耗材分别插入1-2-3-4 进料口，穿过送丝轮，设备将检测到丝料，并逐个自动送入导管内；待丝料都输送到导管入口处则表示输送完成。在使用IFS 时完成以上进料即可以直接进行打印。

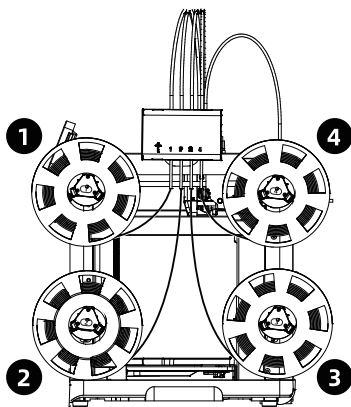

2. 耗材装载后，请手动配置耗材信息。点击对应耗材通道，点击【】按钮，选择对应的耗材类型以及相同或者相似的颜色。点击【确认】。

注：切片文件与编辑设置的耗材类型（即实际装载）一致时，设备才可打印。

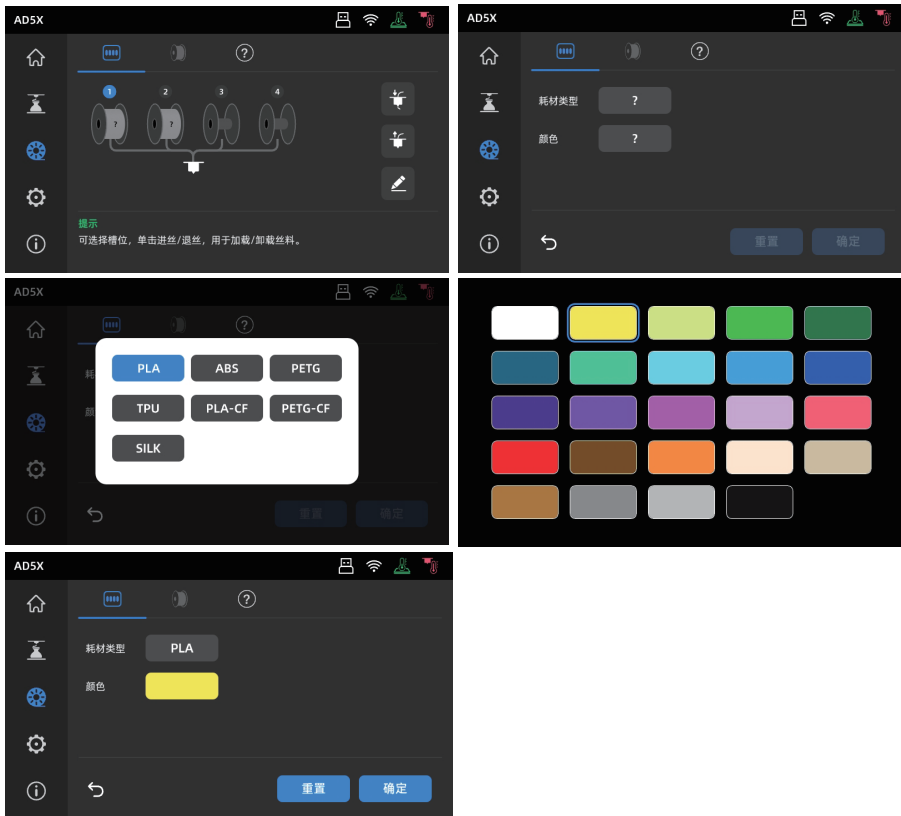



注意事项

***拓展进料：**

不使用IFS时(注：即断开IFS信号线时，单独耗材模式才可被使用，当连接IFS信号线时，设备默认识别使用IFS)，用户可以点击丝料，在屏幕上选择单独进丝的按钮进行进丝（操作方式与IFS相同）

***本设备默认使用IFS进料方式。**

第四章 退出/更换耗材

1. 未进入喷头送丝轮的耗材，即可手动抽出耗材。
2. 若当前耗材仍在喷头内部，点击  -  按钮；耗材将回退到导丝管上方，若当前耗材从喷头回退以后，即可手动抽出耗材。

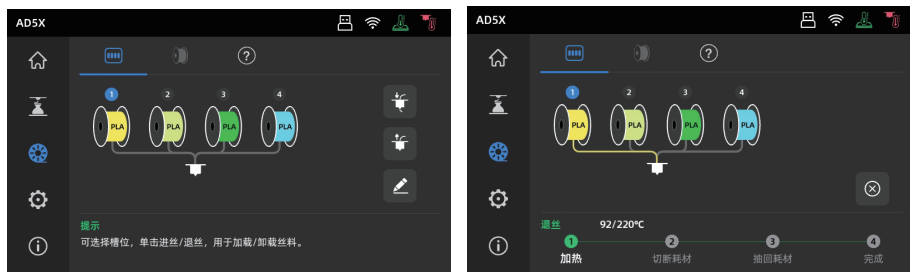

第五章 网络连接

5.1 无线网络连接

1. 点击  -  进入网络连接界面。

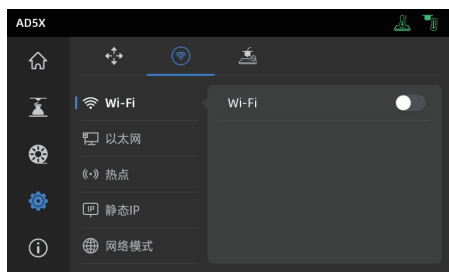

2. 打开Wi-Fi开关，点击连接对应无线网络，连接成功后相应网络会被标记，并在屏幕右上角出现  图标。

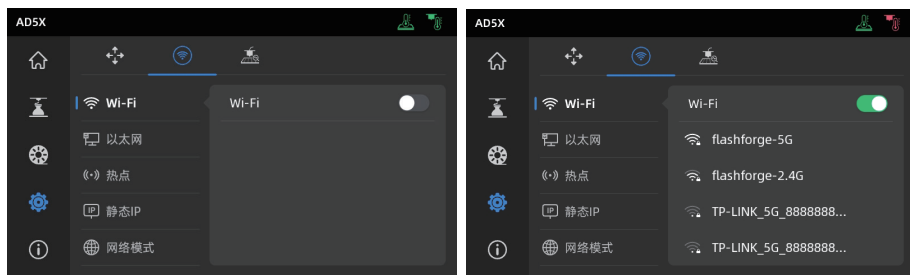

5.2 有线网络连接

1. 选择以太网，根据屏幕提示将网线插入设备背部的网线接口。
2. 连接成功后有线网络会显示已连接，屏幕右上角出现  图标。



第六章 打印

6.1 WI-FI传输文件打印

打印机连接网络成功后，打开Flash Studio Desktop，切片完成后，点击菜单中的打印按钮，选择已连接设备AD5X发送打印。传输文件前需先将打印机连接网络（可使用无线网络或者有线网络），将设备与切片软件进行绑定操作；打印机连接的网络和电脑连接的网络必须在同一局域网中，否则无法连接成功。打印机连接有2种模式：外网模式与局域网模式。

1. 外网模式下打印机连接前需要先登陆/注册闪铸账号；（若手机APP 已经绑定并连接设备，切片软件登陆账户后，则自动显示已连接的设备），若手机APP 未连接绑定，则可以在设备页面点击【+】打开搜索列表，选择连接的机器。

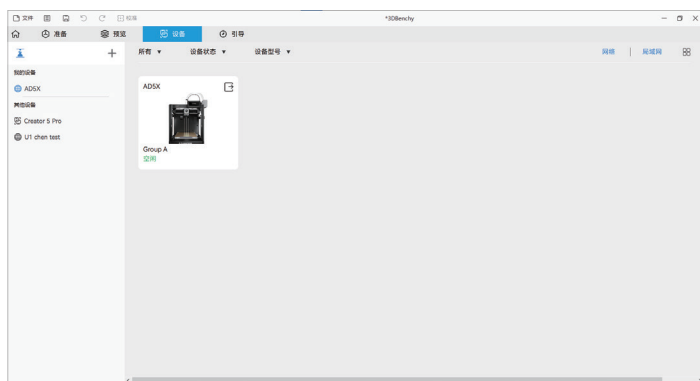

2. 局域网模式下连接打印机需打开打印机【网络模式】-【局域网模式】，切片软件在设备页点击【+】找到对应打印机。选择相应打印机并输入打印机上的设备ID完成连接。

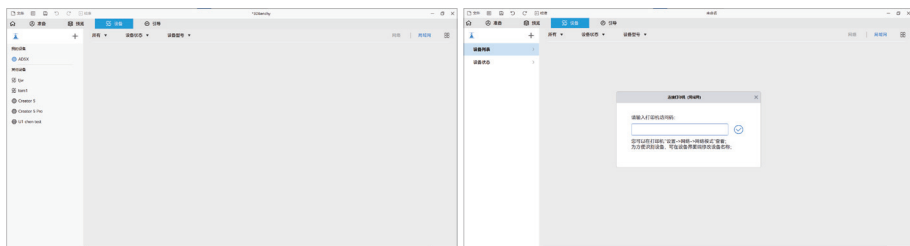

3. 设备连接切片软件之后，可在切片后点击打印单盘，选择对应的打印机，点击发送。

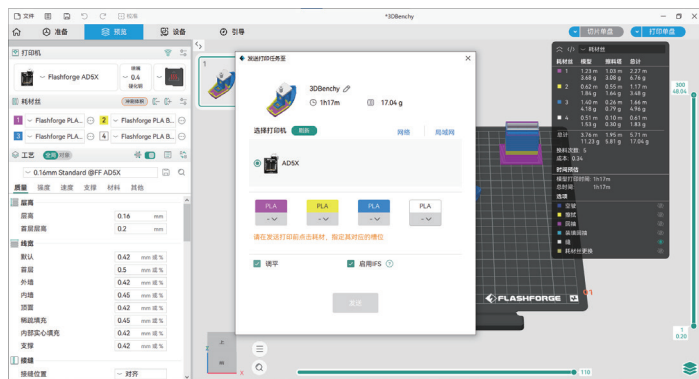

⚠ 注意事项

多色打印时,需要手动配置材料信息,点击对应通道,选择对应或相似颜色的材料(当设备端已经配置好IFS材料信息后,切片软件可读取到该设备对应IFS的信息。)

如图所示:

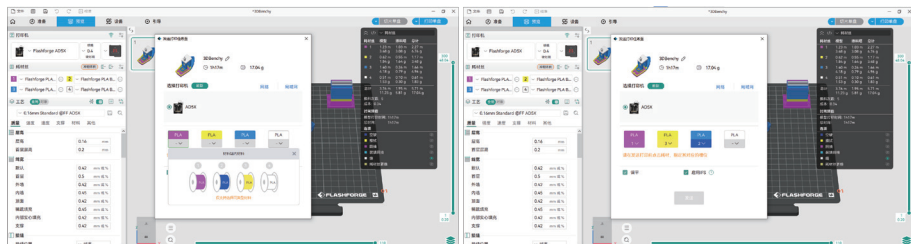

⚠ 注意事项

注意: 切片软件里耗材丝中每个颜色前的数字只是耗材的顺序编号, 和IFS通道序号没有关系。

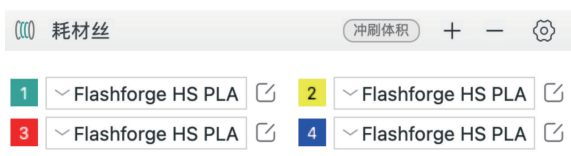

- 在发送打印任务前注意在弹窗页面确认一下每个颜色选择的通道是否符合自己预期。若通道信息是“?”，说明设备上的耗材尚未配置耗材信息，若通道信息是“空”，说明设备上该通道未安装耗材（注意要确保该槽位的耗材与切片材料种类一致）。



6.2 U盘打印

- 在切片软件中选择【导出单盘打印文件】，此选项文件格式为3mf格式。将切片好的文件保存至U盘，将U盘插入设备，选择对应文件打印。

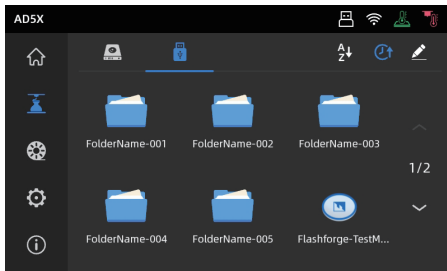

- 点击【下一步】可配置IFS的通道，用户可手动改变实际所需打印的耗材选项。可以在屏幕上手动选择每个颜色对应的通道。



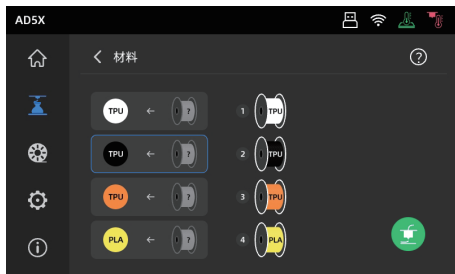

3. 选中左边的框，然后从右边选择需要打印的耗材通道。可重复选择通道。如果没有耗材与文件中指定的颜色匹配，您可以将指定的耗材放置在IFS通道中，或者选择具有相同属性和接近颜色匹配耗材。配置材料通道后，可点击打印。如果打印切片时选择的材料和IFS上的耗材种类不一致，则无法选择该耗材打印。

例如下图：用PLA切片的打印文件，可以选择2/3号通道的PLA进行打印，但无法选择4号通道的ABS。

⚠ 注意事项

当导入到U盘的文件为gcode格式，将无法再次手动修改通道。仅支持3mf格式二次修改。

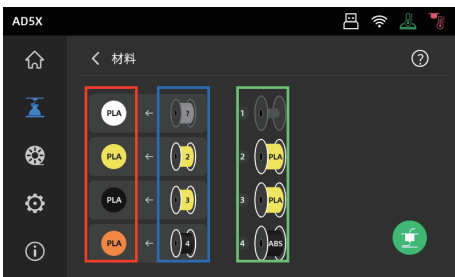

*说明：

红框（最左侧）：显示的为切片软件所配置的耗材类型与颜色。

蓝框（中间）：用户点击可手动修改对应实际装配的耗材盘。选中该栏后，点击绿色框里对应实际通道装载的丝料。选中后将映射到打印材料。

绿色框（最右侧栏）：设备端，实际装载的材料信息。

4. 对应关系可参见【指南】。



6.3 打印后模型移除

⚠ 注意事项

打印完成时，喷嘴和打印平台可能仍处于高温状态，建议冷却后再进行取模型操作！

打印完成后直接取出平台柔性钢板，弯折平台即可取下模型。二次打印时，请确保平台无残余丝料。

模型移除建议：

1. 请将平台板拿到设备外部再进行移除，否则模型碎屑容易留在设备腔体内，建议保持腔体清洁。
2. 建议使用刮刀取下TPU或其他柔性材料打印的模型，使用刮刀进行此操作将确保您可以从面板上剥离柔性模型，而不会对模型造成损坏。

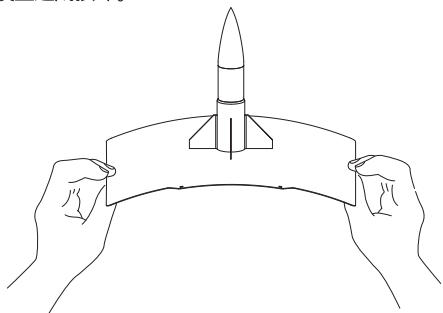

第七章 打印机其他功能介绍

⚠ 注意事项

因固件会不定期升级，界面请以实际显示页面为准。

7.1 调平校准

首次开机引导会执行一次设备校准。后续使用过程中根据情况选择调平或振动补偿。



关于何时需执行调平的说明：

- ◆若是持续只打印PLA材料时，可以只执行一次自动调平，无需进行每次打印前调平，做一次调平有利于提升打印成功率。
- ◆若涉及打印材料类型的切换，例如从PLA材料切换到ABS材料打印，需要执行每次打印前调平。
- ◆若平台与喷嘴距离过远（粘附不住）或者过紧（丝料不吐出）时请执行自动调平。
- ◆每次更换新的打印平台板或者打印喷嘴后，都需执行自动调平，务必注意更换喷嘴后要进行调平，否则会有喷头撞断的风险。

关于何时需执行振动补偿的说明：

- ◆打印模型振纹明显。
- ◆调节同步带松紧后。
- ◆设备长时间未使用，重新启用。

操作说明：

点击  -  进入调平校准页面，选择[调平]或[振动补偿]，点击[开始]按钮，设备将自动进行相应校准操作。（注意事项：校准开始前，请确保平台以及喷嘴尖端无异物残留。）



关于何时执行PID校准的说明:更换新喷嘴或发现喷嘴温度异常时可执行该校准。

7.2 其他功能设置

- ◆ 在设备信息界面中可开启或关闭声音、丝料检测功能以及进行固件升级。丝料检测功能开启时，设备将会在打印中途丝料用完时停止打印。
- ◆ 在无线网络连接时，点击固件升级可查看当前版本以及检测是否有新固件版本，并进行在线固件升级。
- ◆ 打印机名称和设备位置：用户可自定义修改设备名称和位置。对应方便管理，位置的修改可帮助用户管理设备摆放位置作为区分；用户可以自定义组别A/B/C,对应也将显示在app和切片软件中，可用于筛选。

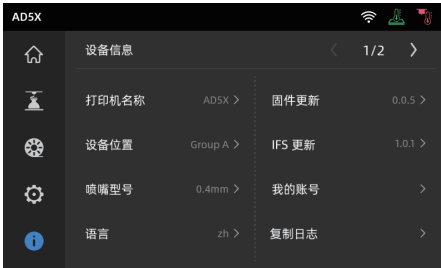

◆断电续打功能。

设备断电后，电力恢复后，设备将有弹窗提示，是否继续打印，选择是，设备将继续打印未完成的模型。

第八章 维护

8.1 打印平台板使用建议

1. PEI 粉末喷涂板需要配合胶水使用，适合打印PLA/PETG/PLA-CF/PETG-CF/ABS/ASA；TPU 打印时无需涂抹胶水。该平台板为设备标配。
2. PEI 膜贴板适合打印PLA/TPU可以不使用胶水，打印PETG 建议配合胶水使用。该平台板可额外购买。
3. PC 贴纸平台板适合打印PC/ABS/ASA。该平台板可额外购买。
4. 平台板涂胶水后可使用水清洗。
5. 平台板若沾染油污，可使用洗洁精清洗。
6. 平台板若长期使用后有较大形变，建议更换新的平台板。

8.2 喷嘴的使用建议

1. 建议一个喷嘴组件对应同类材料使用。尤其是纤维增强材料与PETG，不可与其他材料混用，若混用材料容易引起堵头，降低喷头使用寿命。
2. 使用同个喷嘴打印不同耗材，更换的耗材打印温度低于当前喷头内耗材的打印温度，需要使用更高温的设置来进行吐丝，进行内部丝料的清洗。
3. 需要更换的耗材打印温度高于当前喷头内耗材的打印温度，直接用新耗材进丝即可。
4. 清洗喷嘴内残余丝料，可多次进丝，或手动通针疏通挤出残留丝料。
5. 更换新的喷嘴组件后，请重新进行调平操作。

8.3 设备一般维护

1. 打印每累计1000小时，请对设备关键部件进行保养：X轴，Y轴和Z轴的光轴请用无尘布或者无尘纸擦拭干净。
 2. Z轴丝杆油污清理干净后请均匀涂抹附带或者可替代的润滑脂。
 3. 为了防止耗材受潮断裂在导丝管产生故障，打印机待机超过两天的，请将耗材从机器退出并密封防潮储存。
 4. 请及时清理缠绕在丝杆上的丝料或者异物。
- 维护指南请查看Flashforge wiki。

第九章 Q&A

Q1. 喷嘴堵头怎么办？

排查1：手动按压喷头处的把手，切断丝料，然后拔出导丝管，查看丝料头部是否平整。若不是，剪平整后将导丝管与丝料装入喷头，再点击进丝查看。

排查2：拆卸下喷头，查看喷头处丝料是否堵住。

Q2. 如何更换喷嘴？

喷头内部有丝料时，请先退出丝料，或者手动切断丝料。然后按以下步骤操作：

1. 取下喷头前壳。

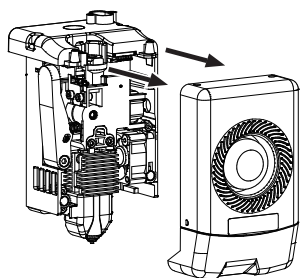

2. 再取下喷嘴保温硅胶套。

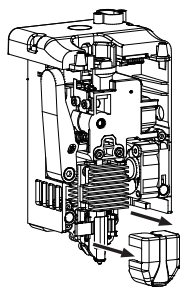

3. 打开散热片和喷嘴卡扣。

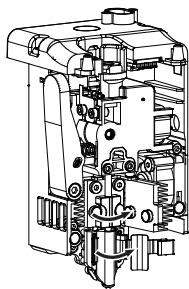

4. 取出喷嘴。

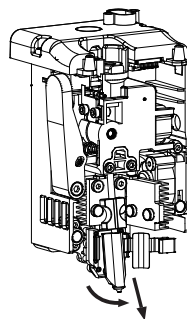

5. 装入新的喷嘴（0.4mm）。

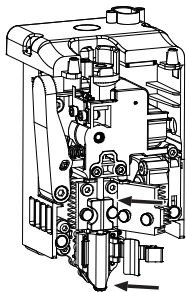

6. 关合散热片和喷嘴卡扣。

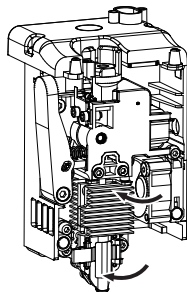

7. 装回喷嘴保温套。

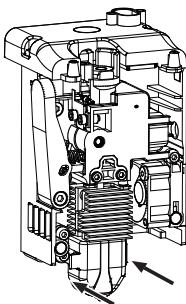

8. 装回喷头前壳。

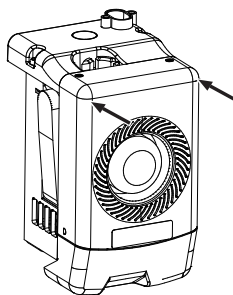

重新安装回喷头时需要注意喷嘴对位，是否扣紧，并且装回保温硅胶套。喷嘴更换完成之后，需要执行一次喷嘴温度校准以及调平校准。

Q3. 更换喷嘴后需要调平校准吗？

需要执行自动调平。喷头安装可能会产生微小误差，为保证打印质量，建议进行调平校准。设备每次打印前默认勾选调平操作。需要进行一次新喷嘴的温度校准。

Q4. 点击打印模型，喷头运动，但打印一开始就没有出丝怎么办？

1. 观察导丝管，确认丝料是否已进入喷头，若无，请再点击进丝按钮，直至丝料从喷头中吐出。
2. 查看喷头是否堵头，若是，解决方案请查看Q1。

Q5. 打印时发现喷嘴与平台相对位置过高（远离平台）或过低（顶到平台）怎么办？如何调整？

请先确认打印平台是否安装到位以及喷嘴上是否有过多残料，若存在以上问题请先处理上述问题，然后进入设置页面，选择调平选项，执行自动调平或开启打印前自动调平。若调平后，发现是整体幅面上由于喷嘴与平台距离过近或者过远而导致的打印不良，可在打印首层时，点击界面的  图标，进行z轴补偿。z₁平台距离过远，点击向上箭头，平台距离过近，则点击向下箭头。

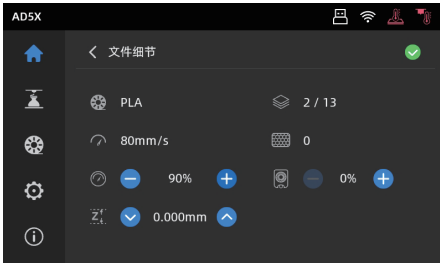
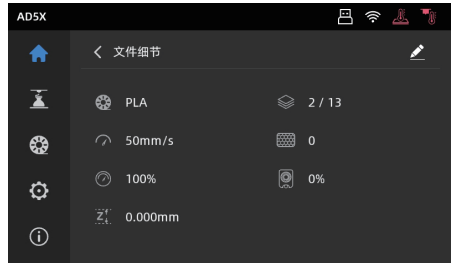
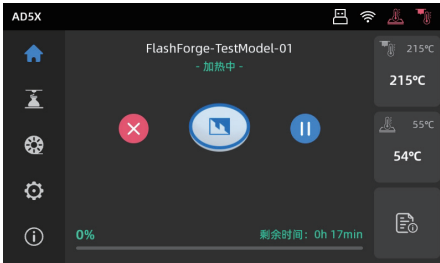

Q6. 可以使用其他品牌的耗材吗？

可以使用其他品牌耗材，但由于不同材料参数温度略有区别，需要经过参数调整配置。

Q7. 打印模型发生翘边或粘不牢现象怎么办？

方案1：增加平台温度可有效缓解此问题，高温可增加平台与模型的粘附力。

方案2：模型切片时选择添加帽檐（brim）可有效缓解此问题。

方案3：涂抹胶水。

方案4：清洗平台板，去除油污。

方案5：确认平台是否放平。可使用调平校准功能。

Q8. 插入U盘后找不到打印文件，屏幕显示全为文件夹怎么办？

U盘格式不正确，设备支持FAT32格式的文件系统，请将U盘格式化成FAT32格式。

Q9. Wi-Fi连接不上怎么办？

1. 请检查Wi-Fi名称是否含有特殊字符，如果有，请修改之后再次尝试。

2. 请检查密码是否含有特殊字符，如果有，请修改之后再次尝试。

Q10. 更新固件注意事项。

请不要在下载或更新固件时断电断网，防止更新失败。

Q11. 为什么开机屏幕白屏？

如果听到开机声音，请更换屏幕或者排线；否则请联系售后人员。

第十章 帮助与支持

闪铸专业的售后服务人员及业务员随时为您待命，非常乐意为您解决在您使用过程中遇到的任何问题。如果您无法从用户手册中找到答案，您可以进入我们的官方网站来搜索问题的解决方案，或者通过电话联系我们。

在我们的官网中可以找到一些常见问题的说明和解决方法。您的许多问题都可以在闪铸集团中文官方网站www.sz3dp.com得到解决。

您可以在周一到周六上午8:00到下午5:00通过电话来联系闪铸售后团队，为您解决问题。如果您在下班时间联系我们，闪铸将在下一个工作日的第一时间给您反馈。若造成不便，我们万分抱歉。

提示

由于更换不同的丝料，会有少量杂质残留在喷头中造成喷头堵塞，疏通后即可，不属于质量问题。若用户使用时存在该问题，请联系售后，并在售后的指导下完成疏通工作。

售后服务热线：400-886-6023

邮箱：support@flashforge.com

公司地址：浙江省杭州市西湖区文二路328号华星发展大厦B座2-4楼

提示：联系售后时，请提供产品序列号，即打印机背部的条形码



S/N: FFAD*****

规格

2.4G Wi-Fi Frequency Range: 2412MHz~2472MHz (Max EIRP: 15.22dBm)

5.2G Wi-Fi Frequency Range: 5150MHz~5250MHz (Max EIRP: 11.66dBm)

5.8G Wi-Fi Frequency Range: 5725MHz~5850MHz (Max EIRP: 10.91dBm)

该产品可在欧盟成员国使用。

在以下情况下，该设备仅限于在5150MHz~5350MHz WLAN频段运行时在室内使用。

制造商：浙江闪铸集团有限公司

地址：东莞市塘厦镇竖朗路1号2号楼3楼



Follow us

Zhejiang Flashforge 3D Technology Co., Ltd.

Address: Floors 2-4, Building B, Huaxing Development Building,
No.328 Wen'er Road, Xihu District, Hangzhou City, Zhejiang Province, China

Service: support@flashforge.com

Suggestions and Complaints: mkt2@flashforge.com

Web: flashforge.com | enterprise.flashforge.com

浙江闪铸集团有限公司

地址：浙江省杭州市西湖区文二路328号华星发展大厦B座2-4楼

服务热线：400 8866 023

建议与投诉：mkt2@flashforge.com

网址：www.sz3dp.com