

User Guide

≡ 用户使用手册 ≡

中文P33

**⚠ WARNING
注意事项**

-
1. Please refer to this Guide for initial printer setup.
 2. Hot! Avoid touching the heating nozzle in operation.
 3. Moving parts in the printer may cause injuries. Do not wear gloves or other sources of entanglement in operation.

1. 请参照本指南完成打印机的初始准备。
 2. 高温危险！打印机喷嘴在工作时会被加热，操作时请避免接触！
 3. 可动部件可能会造成卷入挤压和切割伤害。操作机器时请不要佩戴手套或缠绕物。
-

**⚠ Safety Notice
安全提示**

Do not power on the printer until installation is completed.
请勿在打印机安装完成之前通电。

Thank you for choosing Flashforge!

Even if you are an experienced user or have used our products before, we highly recommend reading this Guide carefully. The instructions and precautions provided will help ensure proper installation and smooth operation.

To help you get the most out of your printer, you can also find operating guidance and practical tips through the following resources:



Scan the QR code to view a detailed unboxing guide and get started quickly.
<https://wiki.flashforge.com/en/creator-series/creator-5m-series/manual/unboxing-your-creator-5m-pro>



Software: Download our official slicing software (Flash Studio Desktop) and mobile app (Flash Studio Mobile) from our website.
<https://www.flashforge.com/pages/download-center>



Quick Start Tutorials: Visit the Flashforge Wiki for more tutorials on printer operation and maintenance.
wiki.flashforge.com

CONTENTS

Notice	02
1. Equipment Introduction	04
1.1 - Printer Components	04
1.2 - Printer Parameters	06
2. Interface Overview	08
2.1 - Main Interface	08
2.2 - Filament Interface	10
2.3 - Control Interface	11
2.4 - Settings Interface	12
3. Basic Operations	15
3.1 - Calibration	15
3.2 - Network Connection	16
3.3 - Loading Filament	16
3.4 - Unloading/Changing Filament	18
4. Software Overview	19
4.1 - Mobile App - Flash Studio Mobile	19
4.2 - Slicing Software	20
5. Printing	26
5.1 - Printing via Wi-Fi File Transfer	26
5.2 - Printing via USB	27
5.3 - Removing Models After Printing	28
5.4 - Additional Functions	29
6. Maintenance	30
6.1 - Build Plate Care & Usage	30
6.2 - Nozzle Care & Usage	30
6.3 - General Maintenance	30
6.4 - Nozzle Replacement	30
7. Q&A	31
8. Help and Support	32

NOTICE

SAFETY NOTICE: PLEASE CAREFULLY READ AND STRICTLY FOLLOW ALL THE SAFETY WARNINGS AND NOTICES BELOW ALL THE TIME.

Note: Each 3D printer undergoes printing tests before leaving the factory. Filament residue on the nozzle or slight scratches on the build plate are normal and do not affect usage.

WORK ENVIRONMENT SAFETY

- ◆ Please keep the workspace clean and tidy.
- ◆ Please ensure the equipment operates away from combustible gases, liquids, and dust. High temperatures generated during operation may react with combustible gases, liquids, or airborne dust, potentially causing fires.
- ◆ Children and untrained individuals should not operate the equipment alone.

ELECTRICAL SAFETY

- ◆ Please properly ground the equipment. Do not modify the plug. Ungrounded equipment/improperly grounded equipment/modified plug will inevitably increase the risk of electric leakage.
- ◆ Avoid exposing the equipment to damp or direct sunlight environments. Humidity will increase the risk of electric leakage. Exposure to sunlight will accelerate the aging of plastic parts.
- ◆ Make sure to only use the power cord provided by Flashforge.
- ◆ Do not use the equipment during thunderstorms.
- ◆ Please turn off the equipment and unplug it if it is not in use for a long time.

PERSONAL SAFETY

- ◆ Do not touch the extruder, build plate, etc., during printing.
- ◆ Do not touch the extruder and build plate after finishing printing to avoid high temperature burns or mechanical damage.
- ◆ Do not wear scarves, masks, gloves, jewelry, or other objects that can easily get tangled into the equipment while operating it.
- ◆ Do not operate the equipment while you are tired or under the influence of drugs, alcohol or medication.

CAUTIONS

- ◆ Keep the inside of the equipment clean. Do not drop metal objects into the grooves at the bottom of the build plate.
- ◆ Please clean up filament debris in time. It is recommended to operate this outside the equipment.
- ◆ Any modification of the equipment by yourself will void the warranty.
- ◆ Please keep the distance between the extruder and build plate for at least 50mm during filament loading. Too-close distance may cause nozzle clogs.
- ◆ Please operate the equipment in a well-ventilated environment.
- ◆ Do not use the equipment for illegal activities.
- ◆ Do not use the equipment to make food storage containers.
- ◆ Do not place printed models into your mouth.

EQUIPMENT ENVIRONMENT REQUIREMENTS

- ◆ Room temperature: 15-30°C; humidity: 20%-70% RH

EQUIPMENT PLACEMENT REQUIREMENTS

- ◆ The equipment must be placed in a dry and well-ventilated environment. A distance of at least 20cm must be reserved around the front, back, left and right sides of the equipment. Recommended storage temperature: 0-40°C

COMPATIBLE FILAMENT REQUIREMENTS

- ◆ When using this equipment, it's recommended to use Flashforge's filaments. If non-Flashforge filaments are used, there will be certain differences in material properties, and print parameters may need adjustments.

FILAMENT STORAGE REQUIREMENTS

- ◆ Please store filaments in a dry and dust-free environment after unpacking. It is recommended to use the matching filament dry box for storage.

LEGAL STATEMENT

- ◆ Users are not authorized to make any modifications to this User Guide.
- ◆ Flashforge shall not be held responsible for any safety incidents resulting from the disassembly or modification of the equipment by the customer. No one is allowed to modify or translate this Guide without Flashforge's permission. This Guide is protected by copyright, and Flashforge reserves the right of the final interpretation of this Guide.
- ◆ First Edition (January 2026)
Copyright © 2026 Zhejiang Flashforge 3D Technology Co., Ltd. All Rights Reserved.

1. Equipment Introduction

1.1 Printer Components

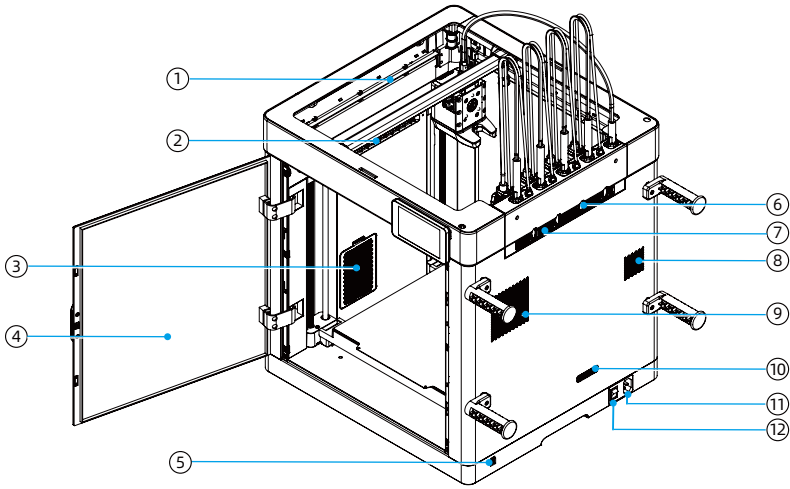

1. Chamber Light
2. Auxiliary Cooling Outlet
3. Air Filter
4. Front Door
5. External Communication Port
6. Filament Inlet
7. Extruder Cooling Vent
8. Power Supply Cooling Vent
9. Chamber Exhaust Outlet
10. Mainboard Cooling Vent
11. Power Socket
12. Power Switch
13. Spool Holder
14. Display Screen
15. Build Plate

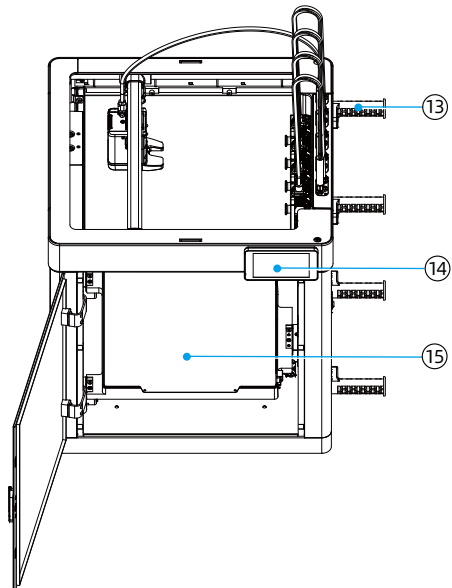

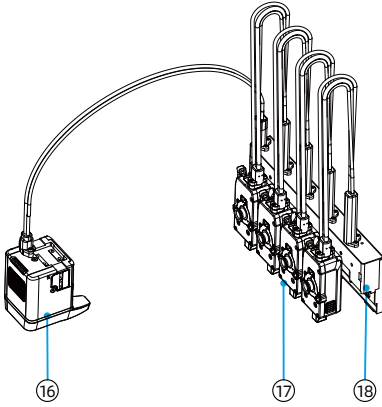

- 16. Extruder Mount
- 17. Extruder
- 18. Extruder Dock

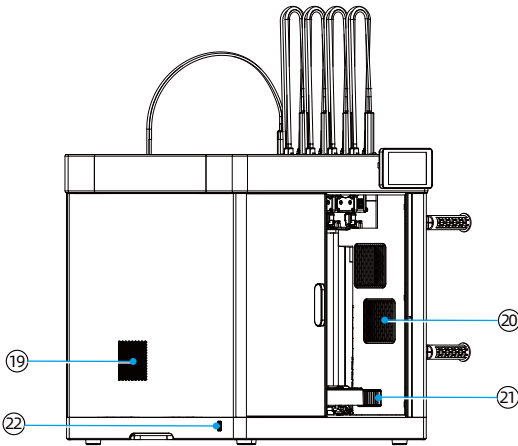

- 19. Chamber Cooling Intake
- 20. Chamber Heating Intake
- 21. Chamber Heating Outlet
- 22. USB Port

1.2 Printer Parameters

Device Name		Creator 5 Pro
Power Supply	Input	100~120V/200~240V AC, 50/60Hz 1200W
Dimensions	Package Dimensions	520×498×540mm
	Device Dimensions	520×425×722 mm (with spool holders and enclosure) 442×413×722 mm (without spool holders, with enclosure)
	Build Volume	256×256×256mm
Body	Material	Aluminum, steel, plastic
Extruder	Extruder Quantity	4
	Extruder Temperature	Max 320°C
	Nozzle Diameter	0.4mm (default); 0.25/0.6/0.8mm (optional)
	Material	Hardened steel
	Supported Filament Diameter	1.75mm
Print Bed	Max Flow Rate	32mm ³ /s
	Removable Build Plate	PEI-coated steel sheet
	Bed Temperature	Max 120°C
Speed	Max Travel Speed	600mm/s
	Max Print Speed	300mm/s
	Max Acceleration	30000mm/s ²
Filament	Recommended	PLA/PETG/TPU 95A/TPU 64D/PLA-CF/ PETG-CF/SILK/PVA/BVOH/S-Multi/ S-PAHT/ABS/ASA/PA-CF/PET-CF/PAHT-CF/ ASA-CF/ASA-GF/ABS-GF/PPA-CF/PPS-CF/ HIPS/TPU 90A (top-mounted)
Feature	Refill Printing	Supported
	Auto Leveling	Supported
	Dynamic Flow Calibration (Auto PA Calibration)	Supported
	Active Chamber Heating	Supported, controllable temperature up to 65°C
	Filament Detection	Supported
	Power Loss Recovery	Supported
	Door Open Detection	Supported (front door, top cover)
	Multi-Device Management	Supported
	Chamber Lighting	Supported
	Air Filtration	HEPA13 filter, activated carbon
	Remote Monitoring	Supported, 1280×720, 30 fps HD camera
	Time-Lapse Video	Supported
	Mobile App Support	Supported
Display Screen	4-inch	
Storage	8G	



Visit our official website for more product information.
www.flashforge.com - [Support]

2. Interface Overview

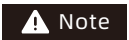

Note

The interface layout may change whenever there is an upgrade of firmware. The following descriptions are for reference only.

2.1 Main Interface

Information displayed when the printer is idle

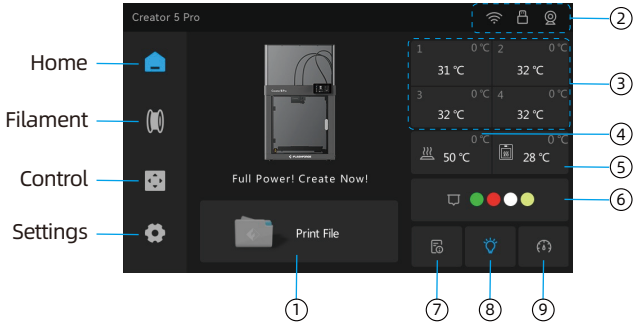

Information displayed when the printer is operating

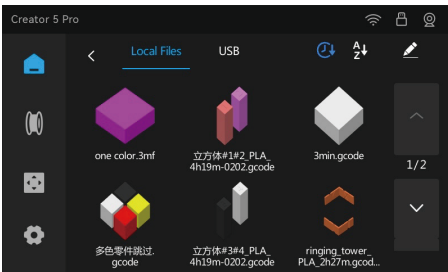
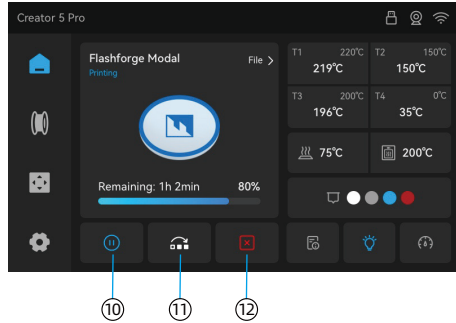

1. Print File: Previously printed files will be saved in the local storage. When a USB flash drive is inserted, files can be viewed under USB files.

2. Status Bar: View real-time printer status, including USB connection, camera installation, Wi-Fi signal, and VDS (Ventilated Drying System) connection (icons appear when connected; no icon appears when not connected).

3. Extruder Temperature: View the current extruder temperature. Tap to enter and set a target temperature.

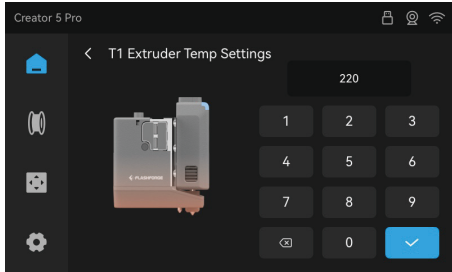

4. Bed Temperature: View the current bed temperature. Tap to enter and set a target temperature.

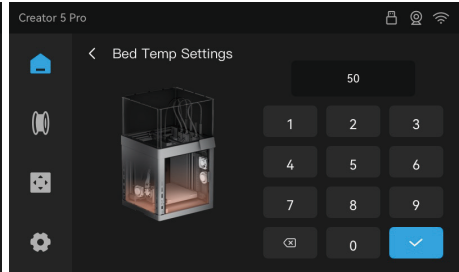

5. Chamber Temperature: View the current chamber temperature. Tap to enter and set a target temperature.

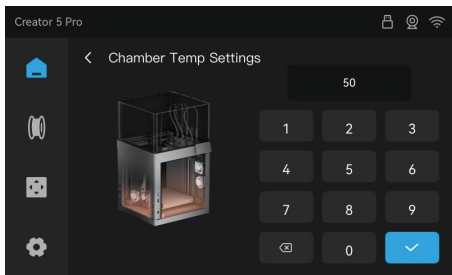

6. Filament Info: View the filament type and color currently set for the extruder.

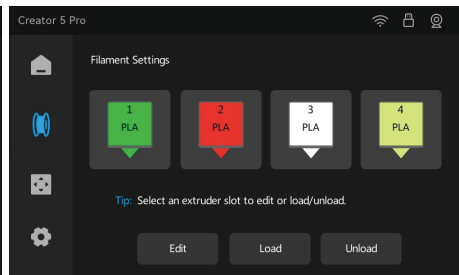

7. Device Info

Idle: View basic printer information.

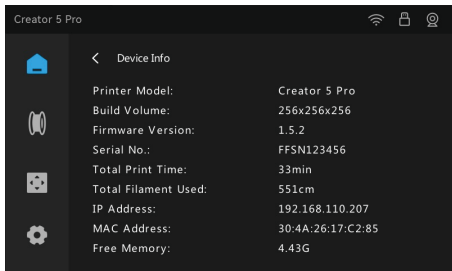

During Printing: View basic printing information of the current model, such as filament type, print layer count, print speed, infill density, cooling fan speed, and auxiliary cooling fan speed. Fan speeds can be adjusted by tapping the edit button in the top-right corner.

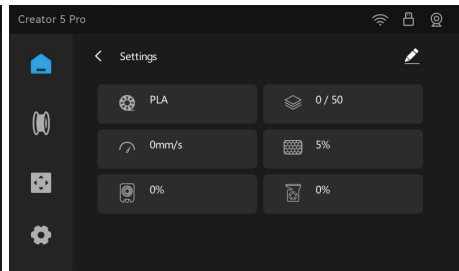

8. Chamber Light Switch: Turn the chamber light on or off.

9. Print Mode: Set the print speed mode as needed.

10. Pause/Start: Pause or start the current print job.

11. Exclude Objects: If a part is damaged during multi-part printing, select the corresponding part to skip it. The skipped part will not be printed. (Note: This feature must be enabled in the slicing software. Go to: Prepare - [Process] - [Others] - Enable "Exclude objects".)

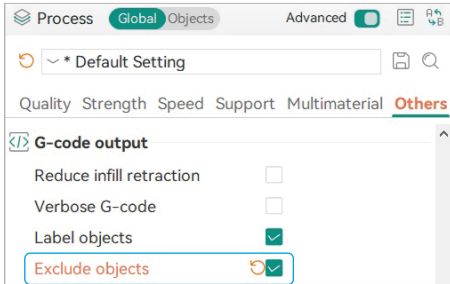
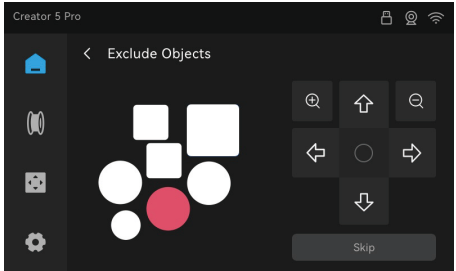
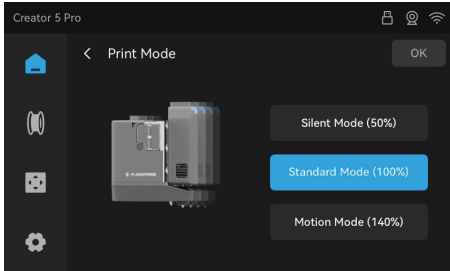

12. Stop: Terminate the current print job.

2.2 Filament Interface

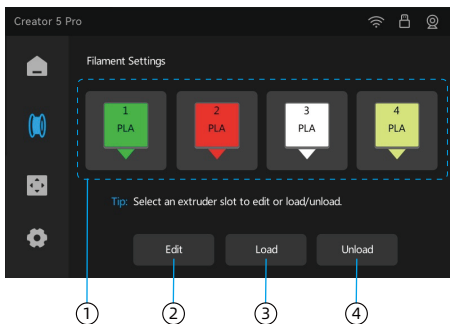

- 1. Extruder:** Select the extruder you want to use.
- 2. Edit:** Set the filament type and color for the selected extruder.
- 3. Load:** Load filament into the selected extruder.
- 4. Unload:** Retract filament from the selected extruder.

2.3 Control Interface

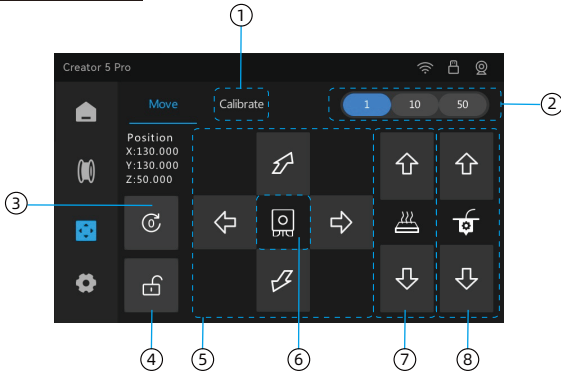

- 1. Calibration:** Perform leveling, vibration compensation, extruder offset calibration, and extruder position calibration.
- 2. Move Distance:** Set the movement distance for the extruder mount and bed. Options include 1mm, 10mm, and 50mm.
- 3. Home:** Reset the X, Y, and Z axes to their default starting positions, providing an accurate reference for subsequent printing.
- 4. Unlock XY & Z Motors:** Release the self-locking state of the XY motors on the extruder mount and the Z motor on the bed, allowing manual movement.
- 5. Extruder Mount Movement:** Tap the directional arrows to move the extruder mount along the X and Y axes.
- 6. Extruder Pickup:** Tap to pick up or release the selected extruder.

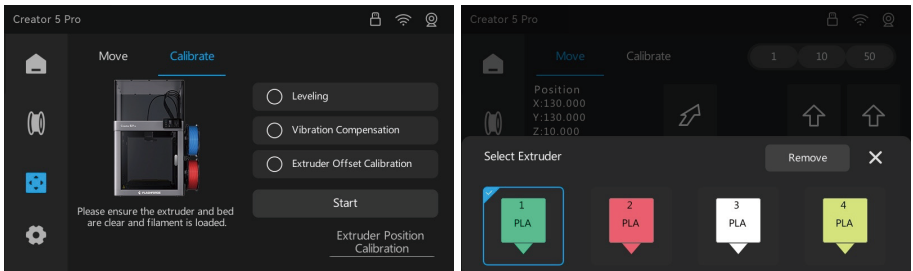

- 7. Bed Movement:** Tap the up or down buttons to raise or lower the bed.
- 8. Extruder:** Tap the up or down buttons to manually retract or extrude filament. (Note: Heat the extruder to the required temperature for the filament before use.)

2.4 Settings Interface

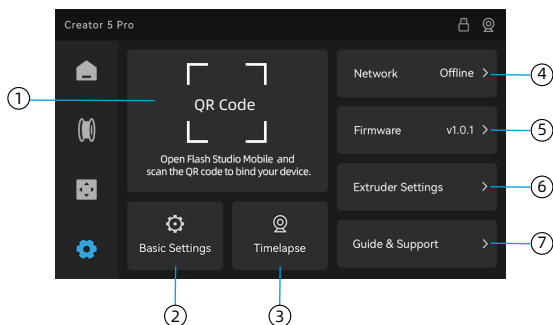

1. Account: With the printer connected to the network, scan the QR code via Flash Studio Mobile to bind the printer (see Section 4.1 for details).

2. Basic Settings

- **Device Info:** View basic printer information.
- **Device Name:** Rename the printer.
- **Device Location:** Organize your printers into groups based on their physical location or area. Custom groups will sync across the App and slicing software, allowing you to filter and monitor progress by group.
- **Free Memory:** View used and total memory capacity. Tap to access local files.
- **Sound:** Enable or disable startup and print completion sounds.
- **Clog Detection:** Detect filament jams or tangles that prevent filament movement during printing.
- **Language:** Set the system language for the printer.
- **Auto Sleep:** The device supports customizable auto-sleep settings. You can choose to enter sleep mode after 5, 10, or 30 minutes of inactivity, or disable sleep entirely.
- **Copy Logs:** Copy logs to a USB flash drive.
- **Factory Reset:** Restore all system settings to their original factory defaults.

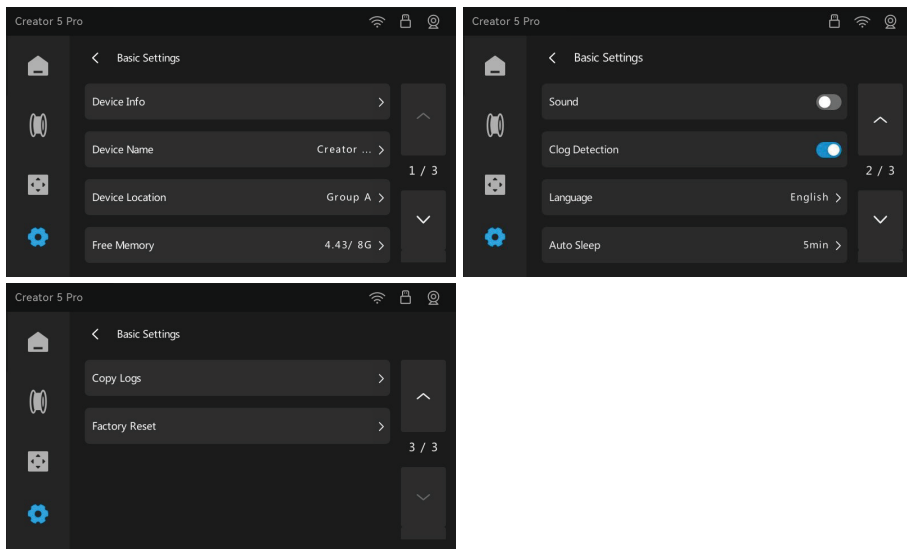

3. Time-Lapse Video: Manage time-lapse video files.

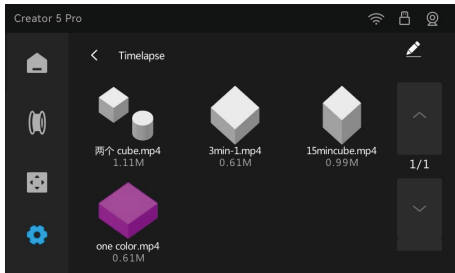

4. Network: Configure the printer's Wi-Fi, IP address, and enable/disable LAN Only Mode.

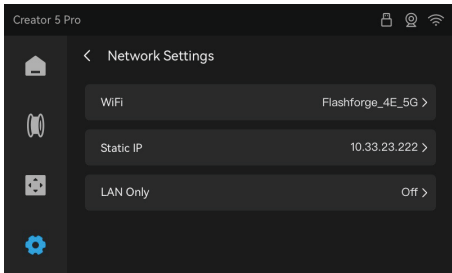

5. Firmware: Check for new firmware versions when connected to the internet and update online.

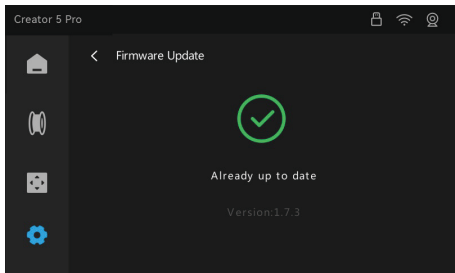

6. Extruder Settings: Manually set the nozzle size.

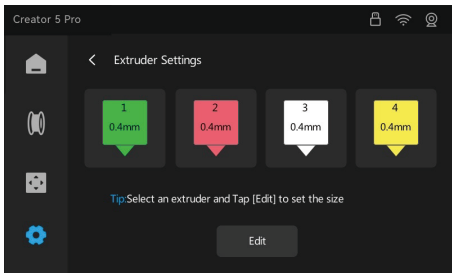

7. Guide & Support

•**User Guide:** Access the printer's manual online.

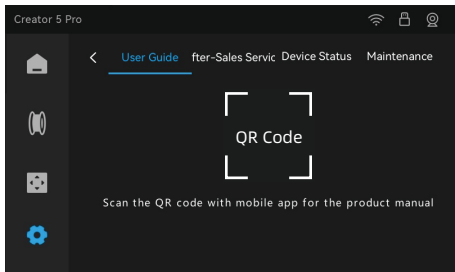

•**After-Sales Support:** View Flashforge's support email.

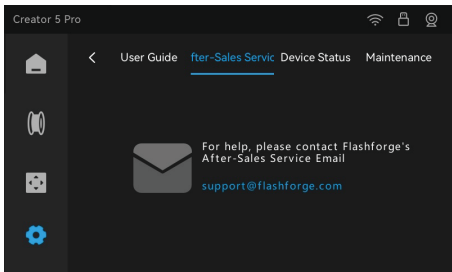

•**Device Status:** View the status of various printer sensors.

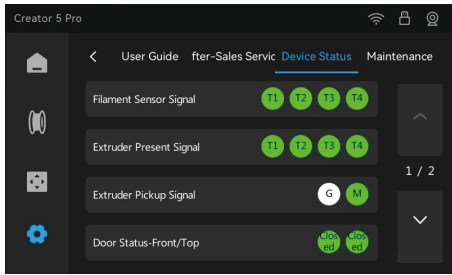

•**Maintenance:** Equipment maintenance operation guidelines and instructions.

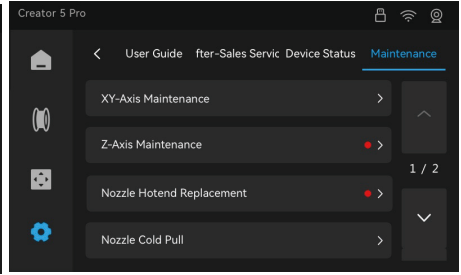

3. Basic Operations

3.1 Calibration

1. Tap [🔧] - [Calibrate] to enter the Calibration interface. You can choose leveling, vibration compensation, extruder offset calibration, or other functions as needed.

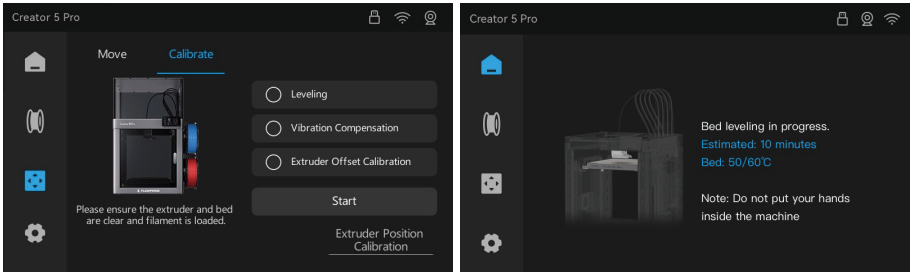

*Calibration Function Descriptions:

Leveling: Multi-point automatic leveling compensates for an uneven bed. Run this if the first layer quality is poor. Before starting, ensure the build plate is free of debris. The bed will first heat to the target temperature, so some preheating time is required. For high-temperature filaments such as ABS or fiber-reinforced composites, it is recommended to enable leveling before printing.

Vibration Compensation: Recommended if you notice ghosting or ringing on printed models, or if the device has been moved. Do not touch the device during calibration. Any vibrations or noises generated during this process are normal.

Extruder Offset Calibration: Recommended before your first multi-extruder print or after replacing a nozzle assembly. This function automatically aligns the relative X, Y, and Z positions between extruders to ensure high-precision, seamless printing. Remove the build plate before starting calibration, and reattach it once completed.

Extruder Position Calibration: Recommended after removing, reinstalling, or replacing an extruder. This aligns the extruder with the mount for precise pickup. Select the extruder you have replaced or removed and manually push the mount until it rests against the extruder; the printer will then detect and calibrate the position.

3.2 Network Connection

1. Tap [] - [Network], turn on the Wi-Fi switch, and then select the desired wireless network to connect.

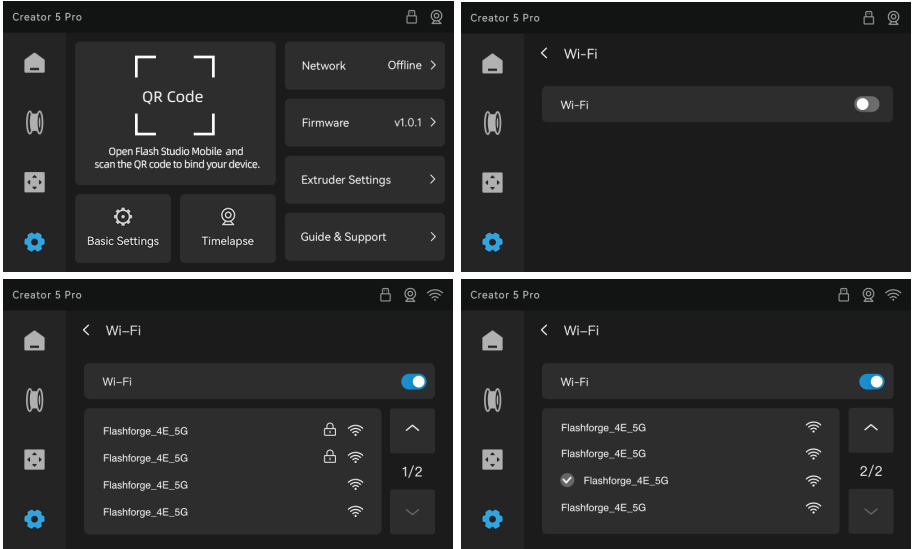

3.3 Loading Filament



Note

When loading filament, please hang each spool as shown below.

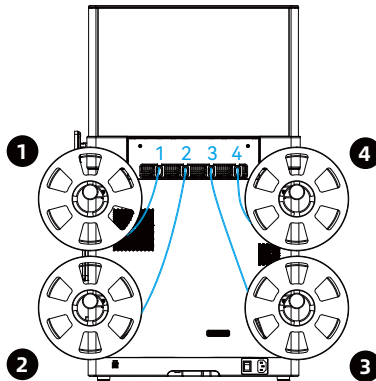

1. Cut off the bent end of the filament. Insert the filament into the filament inlet while pressing down on the extruder lever as shown. Continue feeding the filament until it is fully inserted into the extruder and can no longer be pushed further, and then release the lever.

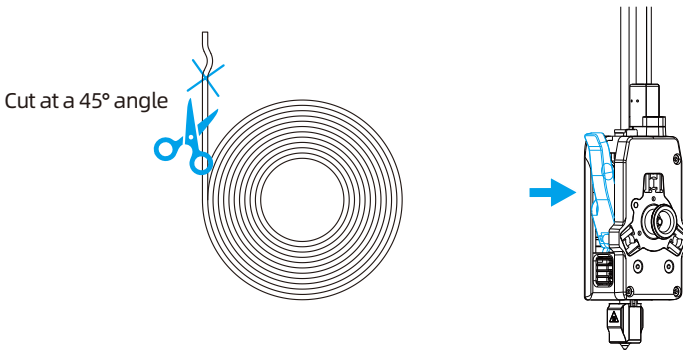

2. Gently pull the filament back. If it cannot be pulled out, the filament has been locked by the extruder feed roller and pre-loading is completed.

3. Tap [] to enter the Filament interface. Select the extruder that matches your inlet number (1-4), and then tap [Edit] to set the filament type and color. Repeat this step to configure other filament channels as needed.

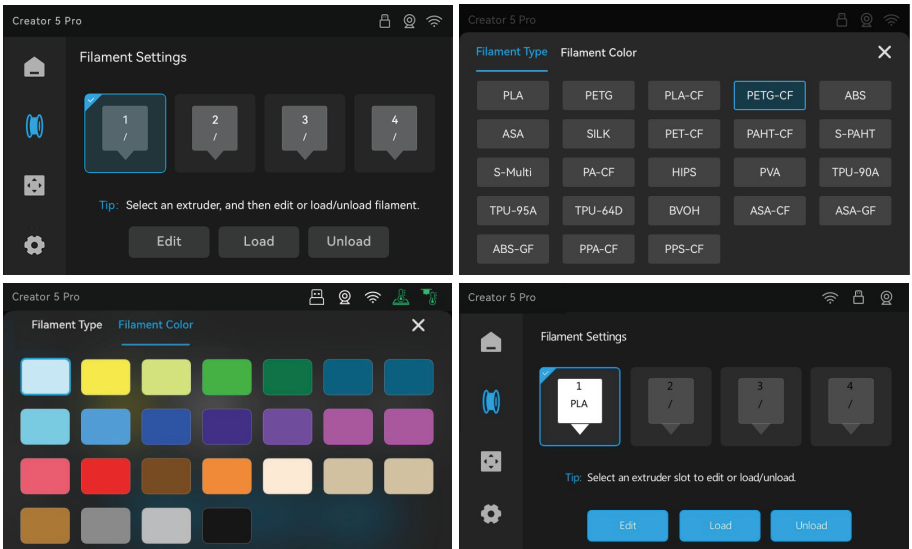

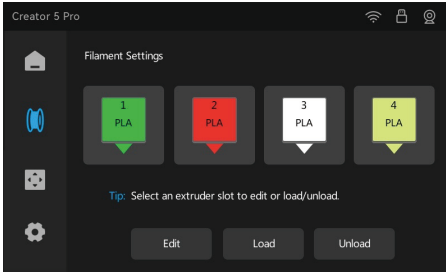

*Unconfigured extruders appear with a semi-transparent background. A "/" indicates no filament detected. A "?" indicates filament is loaded but filament type not configured.

4. Tap [Load] and observe the selected extruder. Filament coming out of the nozzle indicates successful loading.

3.4 Unloading/Changing Filament

1. Remove the extruder and press the extruder lever (which also serves as a filament cutter) all the way down. Once you hear the filament being cut, manually pull the filament out from the outside of the printer.

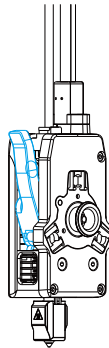

4. Software Overview

4.1 Mobile App - Flash Studio Mobile

Note: Before binding, the printer must be connected to a network.

1. Download Flash Studio Mobile by scanning the QR code (see right) or from the app store, register your Flashforge account, and log in.



2. Tap [⚙️] to enter the Settings interface. Use Flash Studio Mobile to scan the QR code on the printer screen to bind the printer to your account.

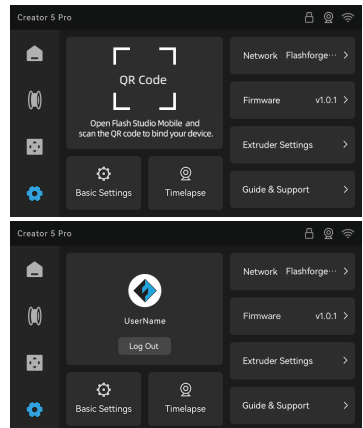
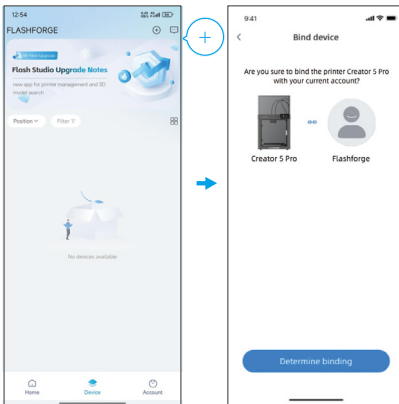

♥ Important Notes

1. The factory default device name is "Creator 5 Pro", and the default location is "Group A".
2. You can modify the printer name and location on the Basic Settings interface as needed.
3. Creator 5 Pro comes standard with a camera, which is enabled by default when the printer is powered on. Open the App, go to the Device page, and tap the printer to enter its details page, where you can access real-time monitoring.
4. The app does not support connections in the LAN Only mode.

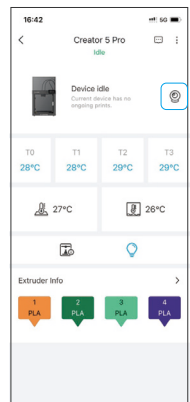

4.2 Slicing Software

Before reading the brief instructions, please ensure you have reviewed the Quick Start Guide and completed the first print.

Before printing, 3D models must be sliced using presets that match your printer.

Recommended Slicing Software: **Flash Studio Desktop**

Download Link: <https://www.flashforge.com/pages/download-center>

Path: software—Flash Studio Desktop

Pre-Printing Workflow:

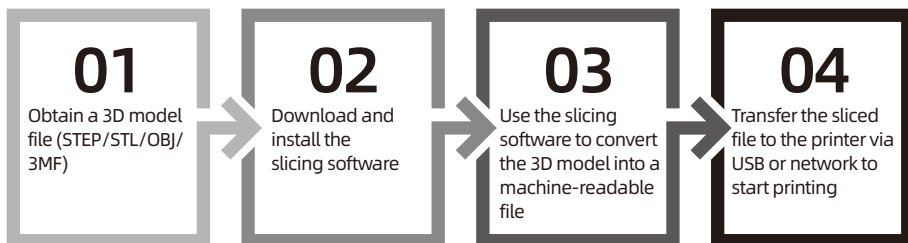

1. Open the installed Flash Studio Desktop.



Flash Studio Desktop

2. Setup Wizard

On first use, follow the setup wizard to select your region, printer model and filament presets.

(Note: You may select all printer models and filament types in the list so that corresponding print parameters are readily available in the software.)

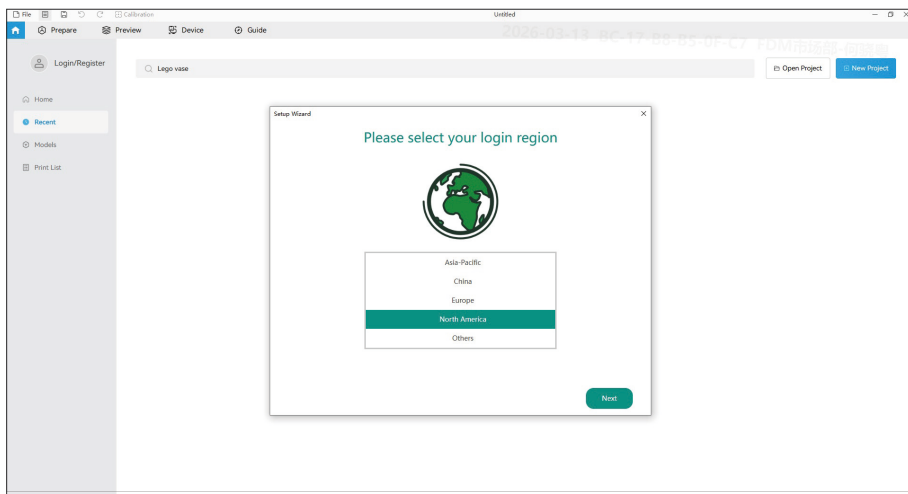

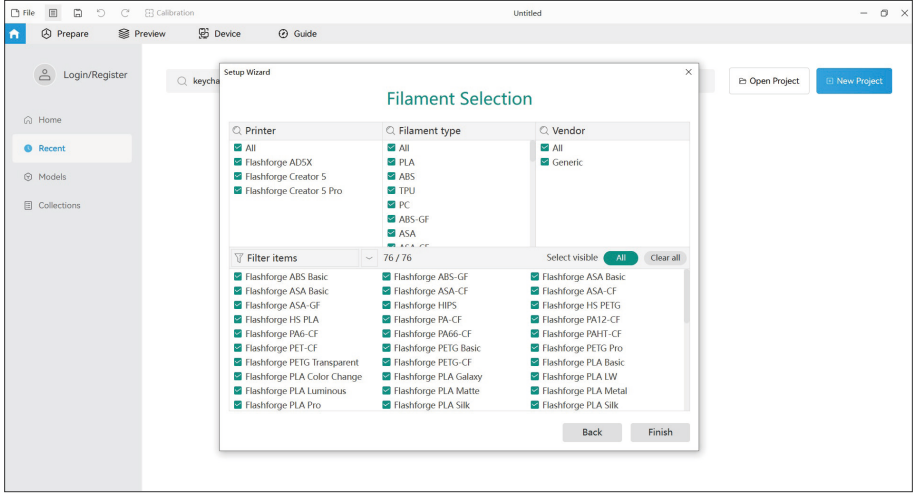
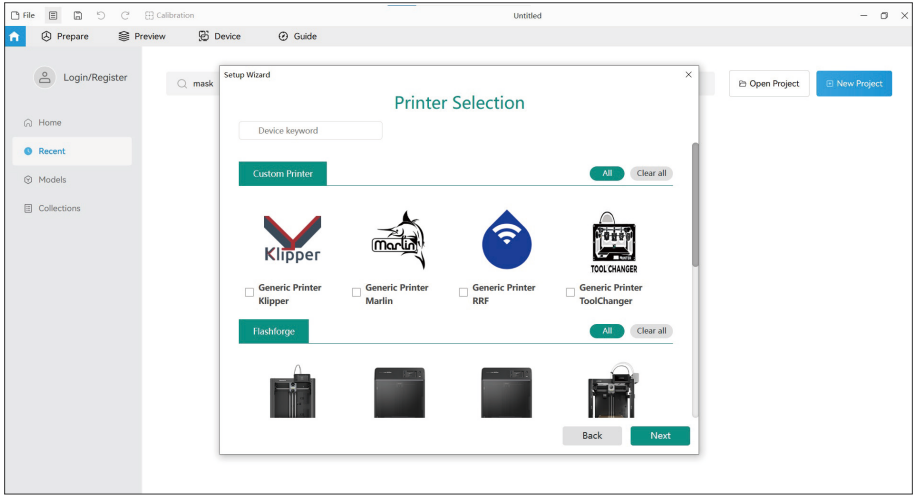

3. Account Login/Registration

Log in to Flash Studio Desktop using your Flashforge account. If you do not have an account, you can register one using your phone number or email address. (Note: Flash Studio Desktop and Flash Studio Mobile share the same account.)

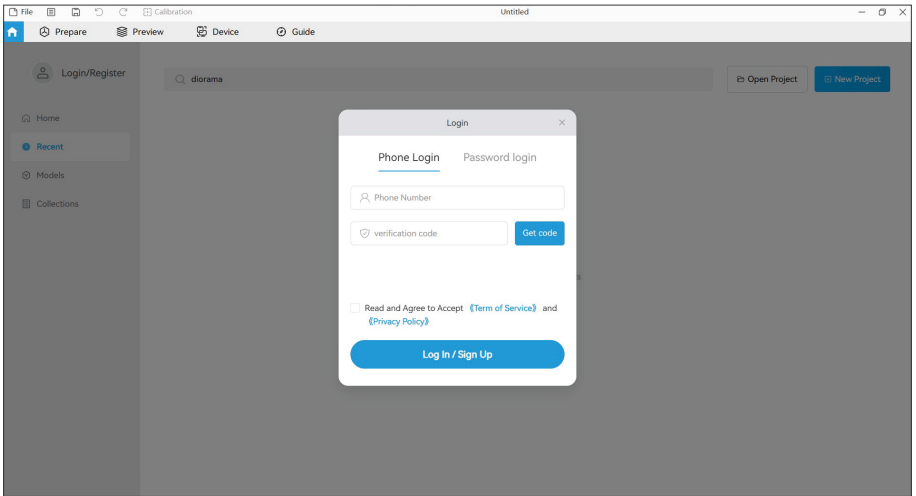

4. Import or Create a Model

On the homepage, you can import downloaded 3D models via [Open Project] or via [File] - [Import] - [Import 3MF/STL...], or click [New Project] to create and edit your own model directly in the software.

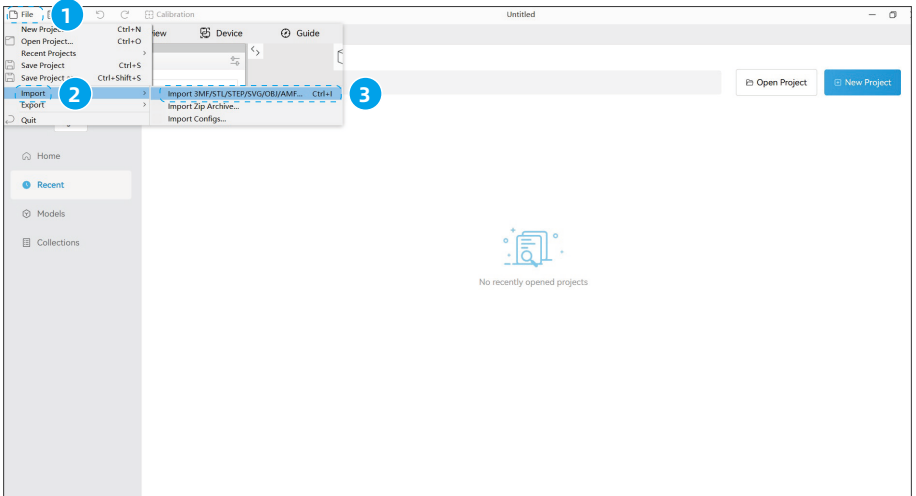

5. Pre-Slicing Setup

Configure your printer model, build plate type, filament type and color, and print parameters in the Printer, Filament, and Process bars. You can use the toolbar above the print area to move, rotate, scale, paint, or add text engraving to the model.

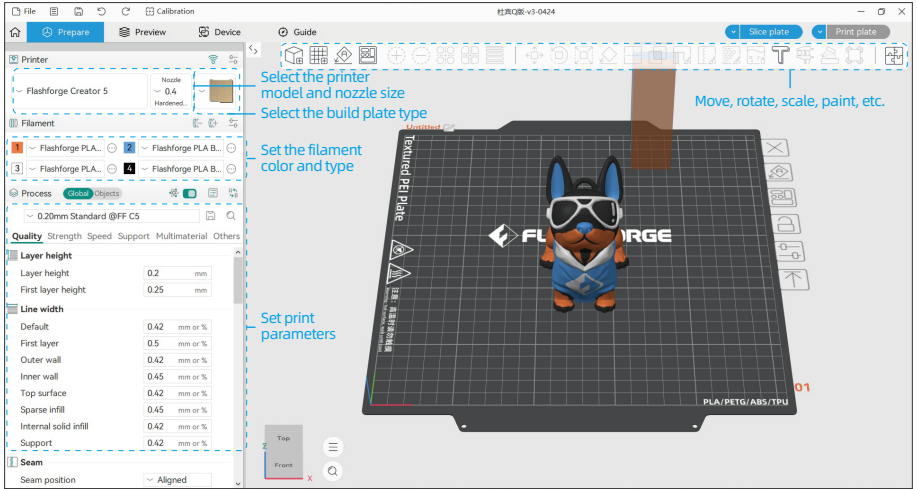

6. Slice

Click [Slice plate]/[Slice all] in the top-right corner. In the slicing results on the right, you can view filament usage (grams), estimated print time, and other information.

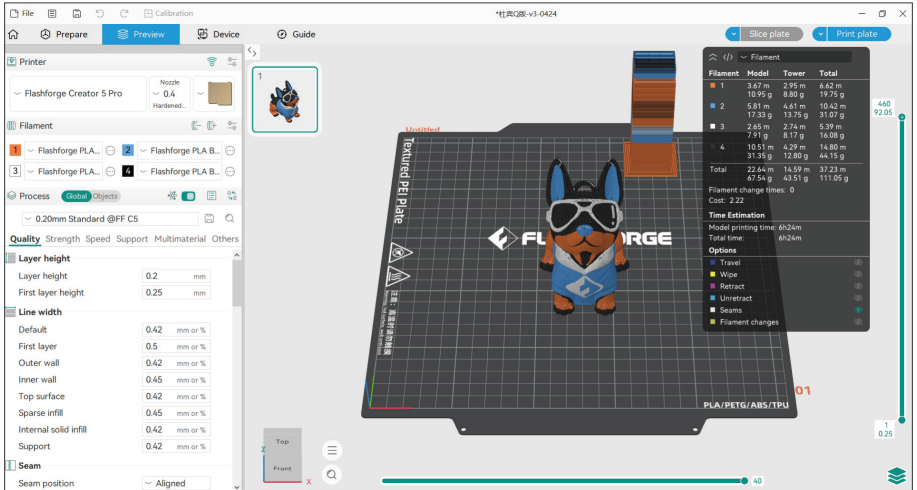

7. Print

After slicing, click [Print plate] in the top-right corner. In the pop-up window, select the corresponding printer and filament configuration.

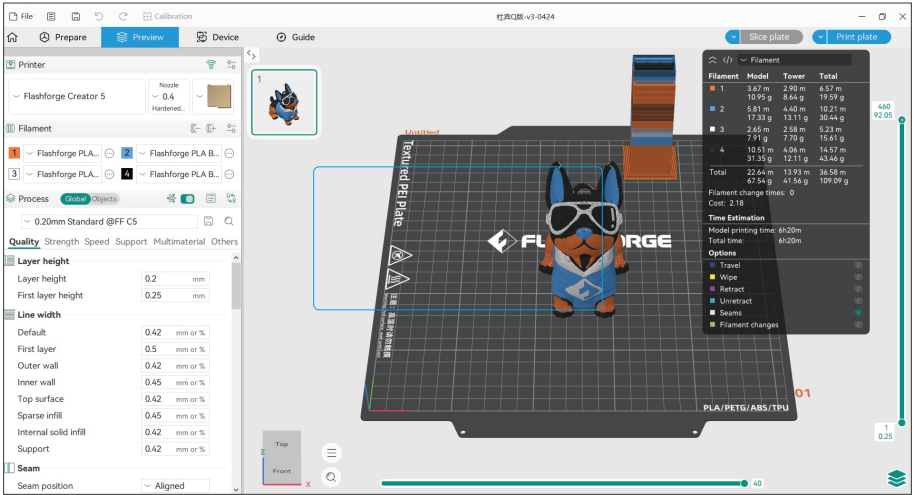

Note

For multi-color printing, filament information must be configured manually. Click the corresponding extruder and select a filament with the same or a similar color. (Once filament information for all four extruders is configured on the printer, the slicing software can automatically retrieve it.) See the images below.

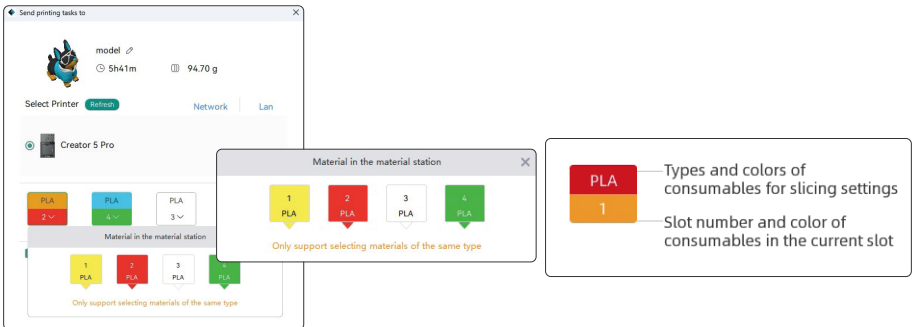

8. Print Management/Monitoring

On the "Device" page, you can view the status and progress of multiple printers. Click a specific printer to enter its details page, where you can monitor print status in real time or remotely control it (pause/cancel printing). You can also edit the filament type and color in the Extruder Filament section, and changes will sync to the printer's firmware page.

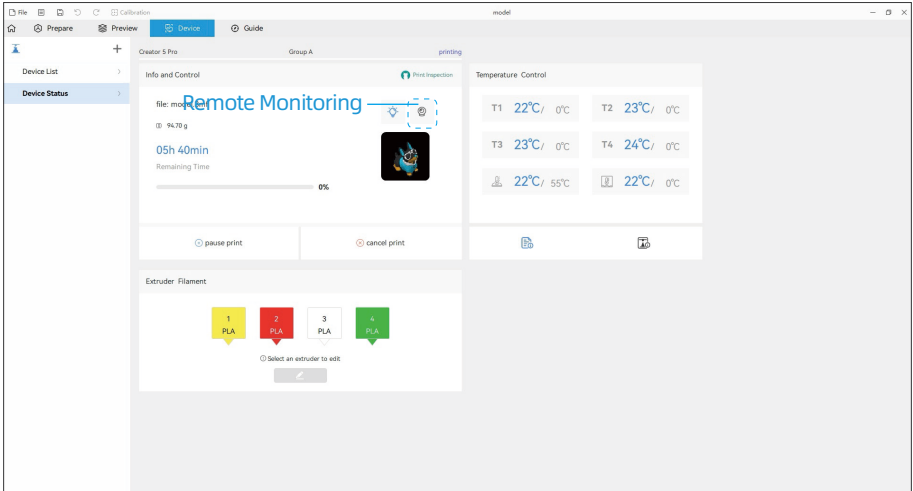
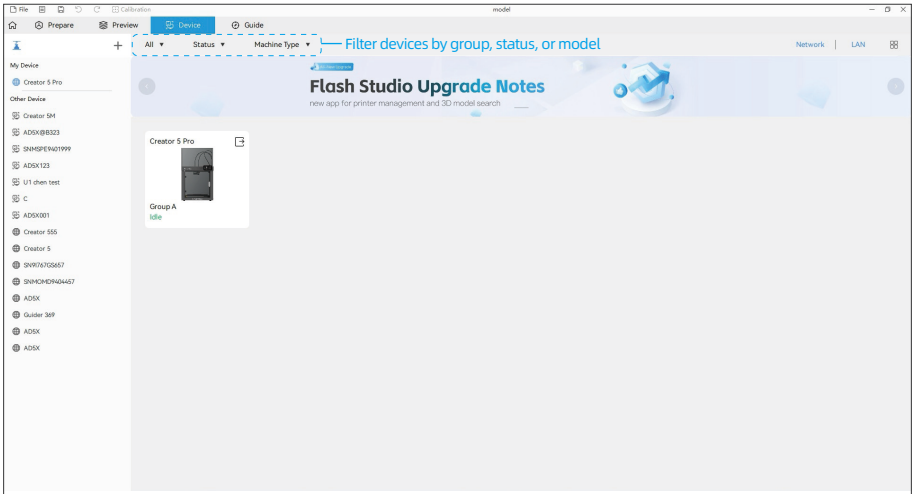

For more information on software operation, refer to related descriptions in the slicing software or visit the official Flashforge Wiki: <https://wiki.flashforge.com/en/home>.

5. Printing

5.1 Printing via Wi-Fi File Transfer

Before remotely transferring sliced files, make sure the printer is connected to a network. There are two connection modes: WAN Mode and LAN Only Mode.

1. WAN Mode: Please log in to or register a Flashforge account before connecting the printer. If the printer has already been bound and connected in the mobile app, it will appear automatically in the slicing software once you log in. If the printer has not been bound in the mobile app, click [+] on the Device page in the slicing software to open the search list and select the printer you want to connect to.

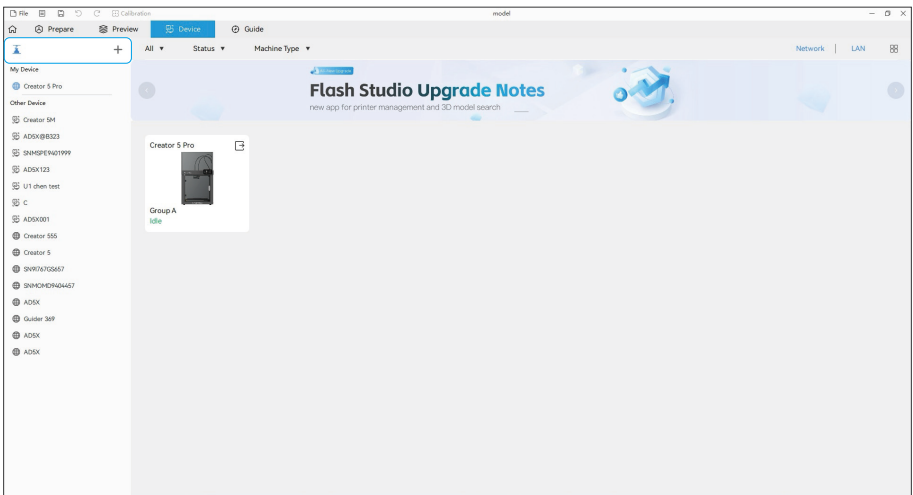

2. LAN Only Mode: Go to [Network] - [LAN Only] and enable [LAN Only Mode]. Then, on the slicing software's Device page, click [+] to find the corresponding printer. Select the printer and enter the Printer ID displayed on the printer screen to complete the connection.

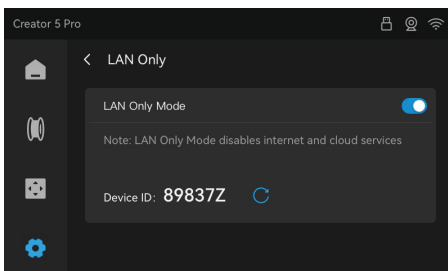

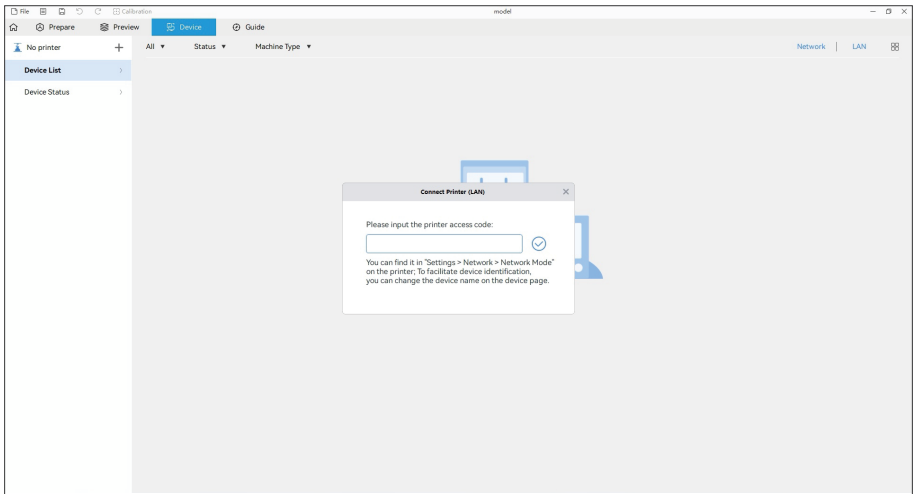
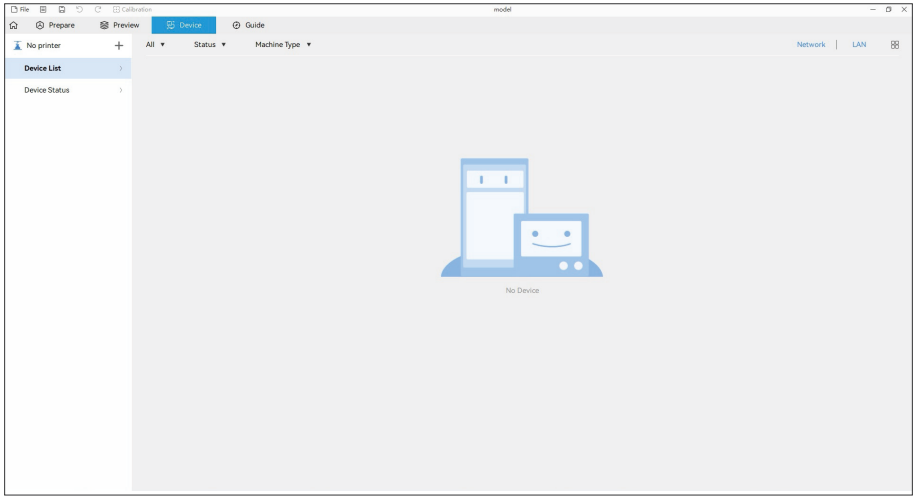

Both modes support sending print jobs remotely from the slicing software.

5.2 Printing via USB

1. In the slicing software, select [Export plate sliced file] (Path: File - Export - Export plate sliced file) and save the sliced file to a USB flash drive. The default export format is 3MF. Insert the USB flash drive into your printer and select the file to print.

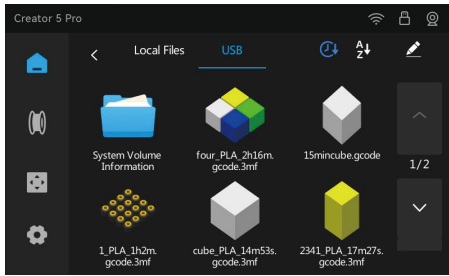

2. Tap [Next] to manually adjust the filament settings for the print. On the screen, you can assign the corresponding extruder for each color. Once configured, tap [Print].

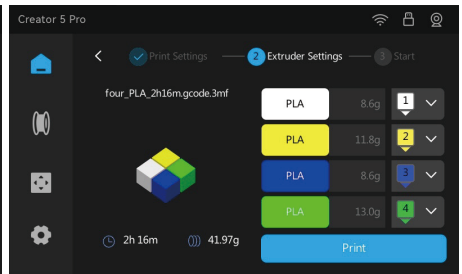
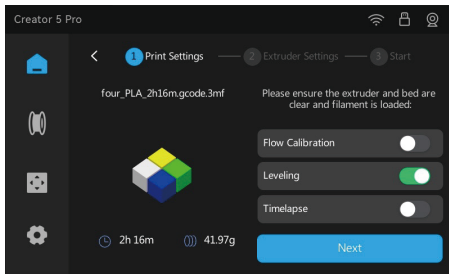

Note

As shown in the image on the right, the left column displays the filament types and colors configured in the slicing software, while the right column shows the actual filaments loaded in the extruders corresponding to each color (which can be selected repeatedly). If the filament type selected during slicing does not match the filament loaded in the extruder, that extruder cannot be selected for printing.

5.3 Removing Models After Printing

Note

After printing is complete, the nozzle and build plate may still be hot. It is recommended to allow them to cool before removing the model!

Once printing is finished, remove the flexible steel plate and gently bend it to pop the model off. Before starting your next print, ensure the build plate is free of any residual filament.

Recommendations for Model Removal:

1. Please take the build plate out of the printer before removing the model. This prevents debris from falling into the chamber and helps keep the interior clean.
2. We recommend using a scraper to remove models printed with TPU or other flexible filaments. This allows you to safely peel the flexible model off the build plate without causing any damage.

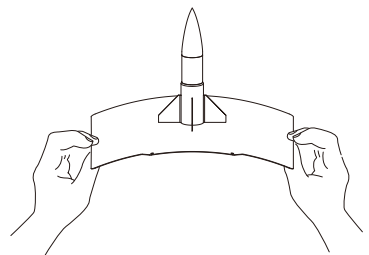

5.4 Additional Functions

1. Using a dry box helps keep filament dry, effectively preventing print failures or quality issues caused by moisture absorption. Once connected to the printer via the communication cable, the VDS (Ventilated Drying System) can be controlled directly from the printer. For detailed instructions, please refer to the VDS User Guide or Wiki documentation.

2. Power Loss Recovery

If a power outage occurs during printing, a prompt will appear once the printer is restarted, asking whether to resume printing. Select [Yes] to continue printing the unfinished model.

6. Maintenance

6.1 Build Plate Care & Usage

1. The build plate can be used with dedicated 3D printing adhesive to improve adhesion.
2. After applying adhesive, the build plate can be cleaned with water.
3. If the build plate becomes contaminated with oil or grease, clean it with dish soap.
4. Avoid scraping the build plate with sharp or hard objects.
5. If the build plate becomes significantly warped after long-term use, it is recommended to replace it with a new one.

6.2 Nozzle Care & Usage

1. It is recommended to dedicate each nozzle assembly to the same type of filament. In particular, fiber-reinforced filaments and PETG should not be mixed with other filaments, as doing so may cause clogs and reduce the nozzle's lifespan.
2. When switching to a different filament using the same nozzle, if the new filament prints at a lower temperature, use a higher temperature setting to purge the old filament.
3. When switching to a filament with a higher printing temperature, simply load the new filament.
4. To clean residual filament inside the nozzle, perform loading several times or manually clear any remaining debris using the unclogging pin tool.
5. After replacing a nozzle assembly, please perform leveling and extruder offset calibration again.

6.3 General Maintenance

1. After every 1,000 hours of printing, perform maintenance on key components: wipe the X, Y, and Z-axis linear shafts clean using a lint-free cloth or paper.
2. After cleaning any oil or debris from the Z-axis lead screw, evenly apply the included or a suitable alternative lubricant.
3. To prevent filament from absorbing moisture, breaking, or causing blockages in the filament guide tube, unload the filament if the printer will be idle for more than two days, and store it in a sealed, moisture-proof container.
4. Promptly remove any filament or foreign objects tangled around the lead screws.
5. For detailed maintenance instructions, please refer to the the machine maintenance page (Path: [🔧] - Guides & Support - Maintenance) or the Flashforge Wiki. (<https://wiki.flashforge.com/en/home>).

6.4 Nozzle Replacement

Before replacing the nozzle, manually cut the filament. Then follow these steps:
Remove the two screws as shown, grip the silicone sock, and pull the nozzle assembly downward to remove it.

⚠ Note

We recommend running an extruder offset calibration after every nozzle replacement. Go to [🔧] - [Calibrate] - enter the calibration interface, select [Extruder Offset Calibration], and follow the on-screen instructions.

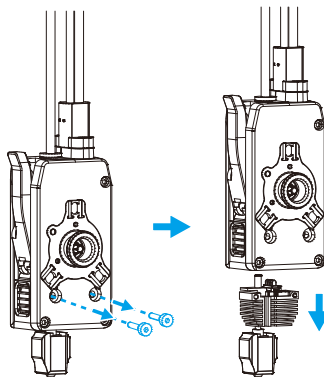

7. Q&A

Q1. What to do if the nozzle is clogged?

Troubleshooting Step 1: Manually press the extruder lever to cut the filament, then remove the guide tube and check if the end of the filament is flat. If not, trim it flat, reinsert the guide tube and filament into the extruder, and then tap [Load] to check.

Troubleshooting Step 2: Remove the extruder and check for any filament stuck inside.

Q2. What to do if the extruder moves when printing starts, but no filament is extruded?

1. Check the filament guide tube to confirm whether the filament has reached the extruder. If not, feed the filament into the extruder and tap [Load]. Follow the on-screen instructions for filament loading until filament comes out from the nozzle.

2. Check whether the nozzle is clogged. If so, refer to the solutions in Q1.

Q3. Can filaments from other brands be used?

Yes. You can use filaments from other brands, but certain parameter adjustments are required due to slight temperature differences in different filaments.

Q4. What to do if your print is warping or not sticking to the bed?

Solution 1: Increase the bed temperature to improve adhesion between the bed and your print.

Solution 2: Add a brim when slicing your model.

Solution 3: Apply glue.

Solution 4: Clean the build plate to remove any oil or grease.

Solution 5: Check if the bed is level. Use the leveling function if needed.

Q5. What to do if no print files are found and the screen only shows folders after inserting a USB flash drive?

The USB flash drive may not be formatted correctly. The printer supports the FAT32 file system. Please format your USB flash drive to FAT32.

Q6. What to do if the Wi-Fi cannot connect?

1. Check if your Wi-Fi name contains any special characters. If it does, please modify it and try again.

2. Check if your password contains any special characters. If it does, please modify it and try again.

Q7. What are the precautions for firmware updates?

Do not power off the printer or disconnect it from the network while downloading or updating firmware to prevent update failure.

Q8. Why is the screen blank at startup?

If you hear the startup sound, please replace the screen or the cable. If you do not hear the startup sound, please contact customer support for assistance.

For more information, please visit the official Flashforge Wiki. (<http://wiki.flashforge.com/en/home>)

8. Help and Support

Flashforge's professional after-sales service personnel and salesmen are on standby for you at any time and are ready to help you with any problem you may have with the printer. If the issues or questions are not covered in this User Guide, you can seek for solutions on our official website or contact us by phone.

There are instructions and solutions to common issues that can be found on our official website. Many of your questions can be resolved on Flashforge's official website (www.flashforge.com) under Support - Wiki, or by visiting the official Wiki.

Flashforge customer support team can be reached by phone from 8:00 AM to 5:00 PM, from Monday to Saturday. In case you contact us during off-duty time, your inquiry will be answered the next working day immediately. We apologize for any inconvenience this may cause.



Note

Changing different filaments may leave minor impurities in the nozzle, leading to clogs. As this can be solved by just unclogging it, it's not owing to a quality issue. If you encounter this problem during use, please contact customer support and follow their guidance for unclogging.

After-sales Service Tel: 400-886-6023

Email: support@flashforge.com

Address: Floors 2-4, Building B, Huaxing Development Building, No.328 Wen'er Road, Xihu District, Hangzhou City, Zhejiang Province, China

Note: Please provide the product serial number which can be found on the barcode at the back of the printer when contacting customer support.



S/N: FFAD*****

Specifications

2.4G Wi-Fi Frequency Range: 2412MHz~2472MHz (Max EIRP: 15.22dBm)

5.2G Wi-Fi Frequency Range: 5150MHz~5250MHz (Max EIRP: 11.66dBm)

5.8G Wi-Fi Frequency Range: 5725MHz~5850MHz (Max EIRP: 10.91dBm)

This product can be used across EU member states.

The device is restricted to indoor use only when operating in the 5150MHz~5350MHz WLAN band in the following.

Manufacturer: Zhejiang Flashforge 3D Technology Co., Ltd.

Address: Floor 3, Building 2, No. 1 Jianlang Road, Tangxia Town, Dongguan City, Guangdong Province, China

感谢您选择FLASHFORGE的产品!

如果您之前使用过我们的产品或熟悉3D打印机的使用，我们仍然建议您仔细阅读此手册，文中的操作说明和注意事项能避免错误的安装和使用。

为了让您能够更好的体验本公司的产品，您还可以从以下方式获取设备相关的操作知识和使用技巧：



扫描二维码查看详细的开箱指南，可帮助您快速上手。
<https://wiki.flashforge.com/en/creator-series/creator-5m-series/manual/unboxing-your-creator-5m-pro>



软件下载：访问地址下载官方切片软件（Flash Studio Desktop）和手机APP（Flash Studio Mobile）
<https://www.flashforge.com/pages/download-center>



快速入门：访问Flashforge官方Wiki，查阅更多机器使用和维护教程。
wiki.flashforge.com

目录

注意事项	35
第一章 设备简介	37
1.1 - 部件介绍	37
1.2 - 设备参数	39
第二章 设备操控界面介绍	40
2.1 - 主界面	40
2.2 - 耗材	42
2.3 - 控制	43
2.4 - 设置	43
第三章 基础操作介绍	46
3.1 - 设备校准	46
3.2 - 网络链接	46
3.3 - 装载耗材	47
3.4 - 退出/更换耗材	48
第四章 软件介绍	49
4.1 - APP应用-Flash Studio Mobile	49
4.2 - 配套切片软件	50
第五章 打印	56
5.1 - Wi-Fi传输文件打印	56
5.2 - U盘打印	58
5.3 - 打印后模型移除	58
5.4 - 其他功能设置	59
第六章 维护	60
6.1 - 打印平台板使用建议	60
6.2 - 喷嘴使用建议	60
6.3 - 设备一般维护	60
6.4 - 喷嘴更换	60
第七章 Q&A	61
第八章 帮助与支持	62

注意事项

安全提示：请确保认真阅读以下安全提示

注意：每台3D打印机在出厂前都经过打印测试，若设备喷头存在耗材残留或打印平台有轻微划痕，都属正常现象，不影响使用。

工作环境安全

- ◆ 请确保设备的工作台面干净整洁。
- ◆ 请确保设备工作时远离可燃性气体、液体及灰尘。设备运行产生的高温有可能会与可燃性气体、液体及空气中的粉尘发生反应从而引发火灾。
- ◆ 儿童及未经培训的人员请勿单独操作设备。

用电操作安全

- ◆ 请务必将设备接地，切勿改装设备的插头。未接地/未正确接地/改装插头必然会增加漏电风险。
- ◆ 请勿将设备暴露在潮湿或暴晒的环境中：潮湿的环境会增加漏电的风险，暴晒会加速设备的塑件老化。
- ◆ 请勿滥用电源线，务必使用闪铸集团提供的电源线。
- ◆ 切勿在雷雨天气使用设备。
- ◆ 如长时间不使用设备，请关闭设备并拔下电源线插头。

个人操作安全

- ◆ 在设备运行时，请勿触碰喷头、平台等位置！
- ◆ 在打印完成时，请勿触碰喷头、平台，以免高温烫伤或机械损伤！
- ◆ 在操作设备时，请勿穿戴围巾、口罩、手套、珠宝装饰等容易卷入设备的物件！
- ◆ 请勿在饮酒、服药之后操作设备！

设备使用提示

- ◆ 保持设备内部整洁，切勿将金属物体掉入打印平台底部的滑槽内。
- ◆ 请及时清理丝料碎屑，建议在设备外进行操作。
- ◆ 自行对该设备进行任何改装将自动失去保修保障。
- ◆ 请在设备进丝操作时，喷头和平台的距离至少保持50mm的距离。距离过近可能会造成喷头堵塞。
- ◆ 请在通风的环境下操作设备。
- ◆ 请勿利用该设备进行违法犯罪的活动。
- ◆ 请勿利用该设备制作食物储存类产品。
- ◆ 请勿将打印模型放入口腔。

设备运行环境要求

- ◆ 室内温度在15-30°C为宜；湿度在20%-70%为宜。

设备放置要求

- ◆ 设备需要被放置于干燥通风的环境中。设备前后左右四周必须预留至少20cm的空间距离。存储温度在0-40°C为宜。

设备兼容耗材要求

- ◆ 在使用该设备时，建议使用闪铸提供或指定的耗材。如使用非闪铸提供耗材，材料特性有所差异，打印参数可能需要调整。

耗材存储要求

- ◆ 耗材拆封后请保持储存环境干燥，无尘，建议配套干燥盒存储。

法律申明

- ◆ 用户无权对此使用手册进行任何修改。
- ◆ 客户若自行拆装或改造设备造成任何安全事故，闪铸集团概不负责。未经闪铸集团允许，任何人不得对该手册进行修改或翻译。本手册受版权保护，闪铸集团对本手册保留最终解释权。
第一版（2026年01月）
- ◆ @Copyright 2026浙江闪铸集团有限公司版权所有

第一章 设备简介

1.1 部件介绍

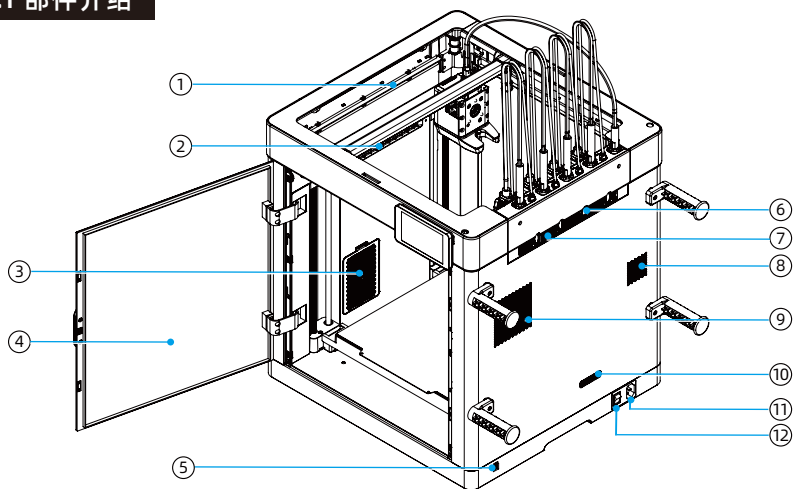

1. 腔体照明灯
2. 辅助冷却出风口
3. 空气滤网
4. 前门
5. 外接通信接口
6. 进料口
7. 喷头散热口
8. 电源散热口
9. 腔体外排风口
10. 主板散热口
11. 电源插座
12. 电源开关

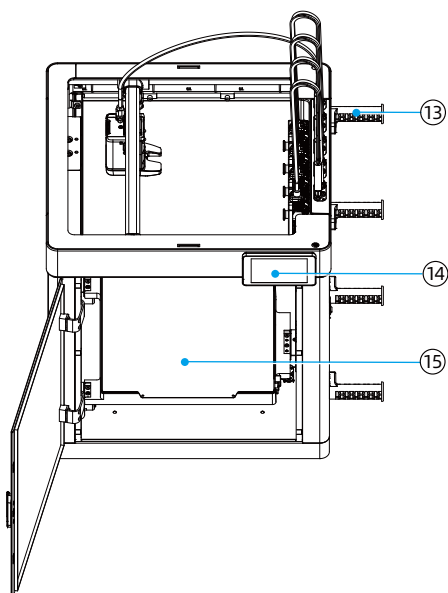

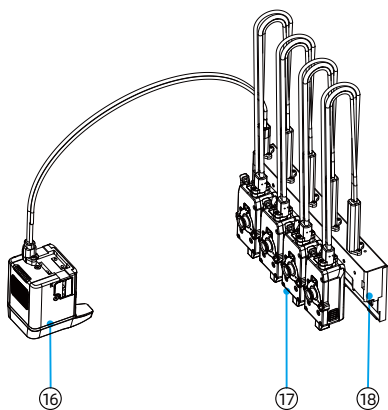

- 16. 喷头座
- 17. 喷头
- 18. 喷头坞

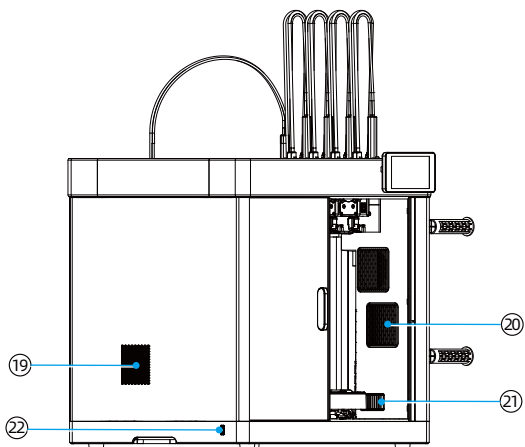

- 19. 腔体冷却进风口
- 20. 腔体加热进风口
- 21. 腔体加热出风口
- 22. USB接口

1.2 设备参数

设备名称		金刚狼5 Pro
电源	输入	100~120V/200~240V AC 50/60Hz 1200W
尺寸	包装尺寸	520×498×540mm
	机身尺寸	520×425×722mm (带耗材架带封闭罩) 442×413×722mm (不带耗材架, 带封闭罩)
	打印尺寸	256×256×256mm
机身	材质	铝材、钢材、塑料
喷头	喷头数量	4
	喷头温度	最高320°C
	喷嘴口径	0.4mm默认 [0.6/0.8/0.25mm可选]
	材质	硬化钢
	支持耗材尺寸	1.75mm
打印平台	最大喷头流量	32mm ³ /s
	可移除平台配置	PEI涂层钢板
	平台温度	最高120°C
速度	喷头最大移动速度	600mm/s
	最大打印速度	300mm/s
	最大加速度	30000mm/s ²
耗材	推荐打印	PLA/PETG/TPU-95A/TPU-64D/PLA-CF/ PETG-CF/SILK/PVA/BVOH/S-Multi/ S-PAHT/ABS/ASA/PA-CF/PET-CF/PAHT-CF/ ASA-CF/ASA-GF/ABS-GF/PPA-CF/PPS-CF/ HIPS/TPU-90A(顶部外挂)
功能	续料打印	支持
	自动调平	支持
	动态流量校准 (自动PA校准)	支持
	主动腔体加热	支持, 最高可控温度65°C
	丝料检测	支持
	断电续打	支持
	开门检测	支持 (前门、顶罩)
	多机管理	支持
	腔体照明	支持
	空气过滤	HEPA13 滤网、活性炭
	远程监控	支持, 1280×720; 30 fps 高清摄像头
	延时摄影	支持
	支持APP	支持
显示屏	4英寸	
机身内存	8G	



更多产品相关资料您可以登陆内铸官网查看。
www.sz3dp.com - [技术支持]

第二章 设备操控界面介绍

⚠ 注意事项

因固件会不定期升级，UI界面请以实际显示页面为准，以下仅为功能简介。

2.1 主界面

打印机闲置时主界面显示信息



打印机工作中主界面显示信息

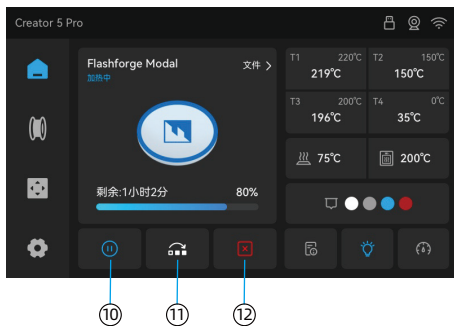

1. 打印文件：打印过的文件将在本地文件中保留，插入U盘后可在USB文件中查看。
2. 状态显示栏：显示打印机实时状态，包括USB连接状态，摄像头安装状态、Wi-Fi信号状态、VDS（通风循环干燥系统）连接状态（已连接显示图标，未连接不显示）。



3. 喷头温度：显示当前喷头温度，点击输入数值，可设置对应喷头温度。



4. 热床温度：显示当前热床温度，点击输入数值，可设置热床的温度。

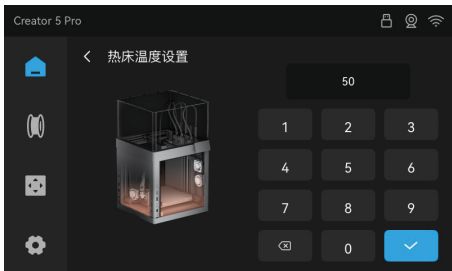

5. 腔体温度：显示当前腔体温度，输入数值，可设置腔体温度。

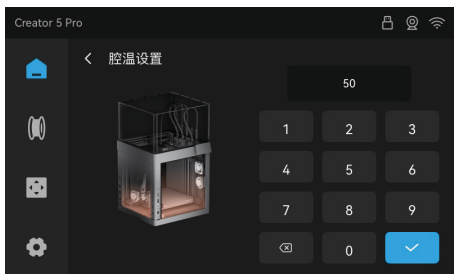

6. 喷头耗材：显示当前喷头设置的耗材类型和颜色信息。



7. 设备信息

空闲状态：可查看打印机的基本信息。



执行打印任务中：可查看当前模型基本打印信息，如：耗材类型、打印层数、打印速度、填充密度、冷却风扇速率、辅助散热风扇速率，风扇速率均可点击右上角编辑按钮进行调整。

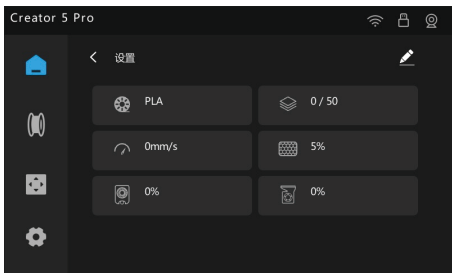

8. 腔体灯开关：开启和关闭腔体照明功能。

9. 运动模式：可以按比例设置打印速度模式。

10. 暂停/开始：暂停或开始当前的打印任务。

11. 跳过零件：打印多模型时发现单个零件打印损坏时，可选中对应损坏的模型，进行跳过。后续将不再打印被跳过的模型。（备注：零件跳过功能可在切片软件中开启，操作路径：准备页面 - 【工艺】 - 【其他】 - 开启对象排除）

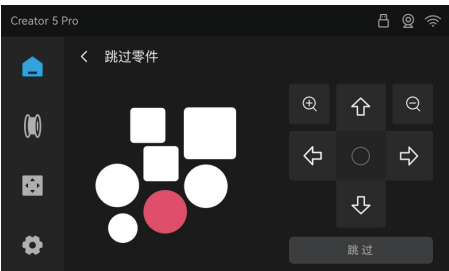
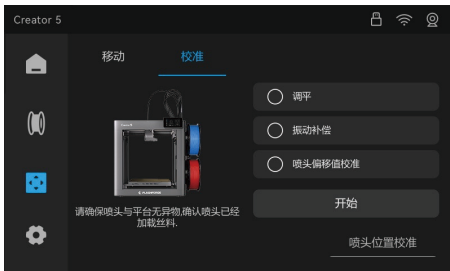

12. 停止：终止当前的打印任务。

2.2 耗材



1. 喷头：选择需要执行操作的喷头。
2. 编辑：可对选中的喷头设置耗材类型和耗材颜色。
3. 进丝：对选择的喷头进行进丝操作。
4. 退丝：对选择的喷头进行退丝操作。

2.3 控制

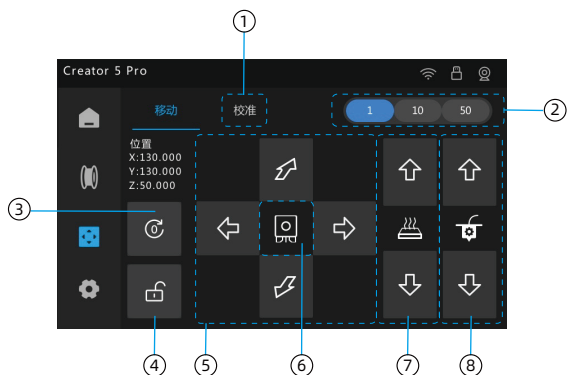

1. 校准：包括调平、振动补偿、喷头偏移值校准、喷头位置校准。
2. 位移距离：对喷头座和打印平台位置距离的设定，分为1mm、10mm和50mm。
3. 归零：将X、Y、Z三个轴的位置重置为系统预设的起始点，为后续打印提供精确的运动基准。
4. XY、Z轴电机解锁：解除喷头座XY轴电机和热床Z轴电机的自锁状态，以便手动移动喷头座和热床。
5. 喷头座位移：点击方向按钮，控制喷头座在X轴和Y轴上移动。
6. 喷头座抓取：点击可以选择抓取或移除对应的喷头。

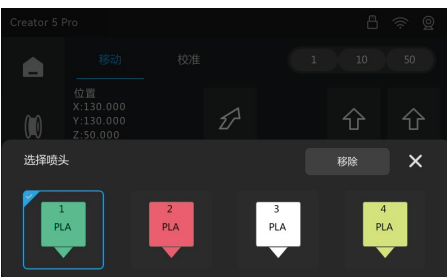
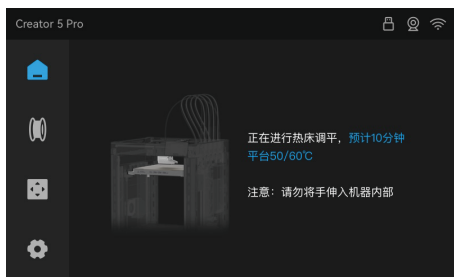

7. 热床升降：点击上下按钮，控制热床的升降。
8. 挤出机：点击上下按钮，手动挤出或退出耗材。（备注：使用前需加热喷头至当前耗材所需的挤出温度）

2.4 设置

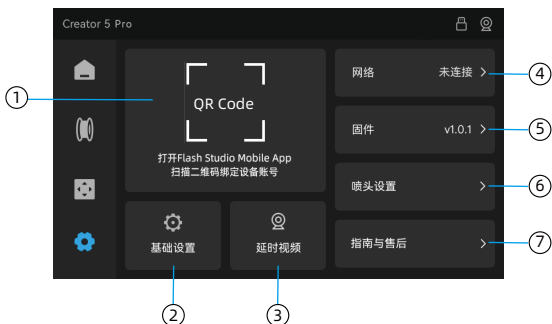

1. 账号：打开Flash Studio Mobile，机器联网状态下，扫描二维码即可绑定打印机。（具体操作可查看说明书3.4.1 App应用部分）

2. 基础设置

- 基本信息：查看打印机的基本信息。
- 设备名称：修改打印机名称。
- 设备位置：帮助用户管理多个打印机群组，可按照放置位置或区域进行区分。用户可自定义打印机组别，App和切片软件中会对应显示，用户可根据设备位置筛选查看不同群组打印机打印进度或状态。
- 剩余内存：显示内存已使用容量和最大容量，点击可进入本地文件。
- 声音：打开和关闭开机提示音和打印完成提示音。
- 堵头检测：在打印过程中，检测缠料或堵头导致的丝料不移动的问题。
- 语言：设置打印机系统语言。
- 自动休眠：设备支持自定义自动休眠，可设置 5/10/30 分钟无操作休眠，或不休眠。
- 复制日志：将日志拷贝到U盘。
- 恢复出厂设置：将系统中的各项设置恢复到出厂状态。

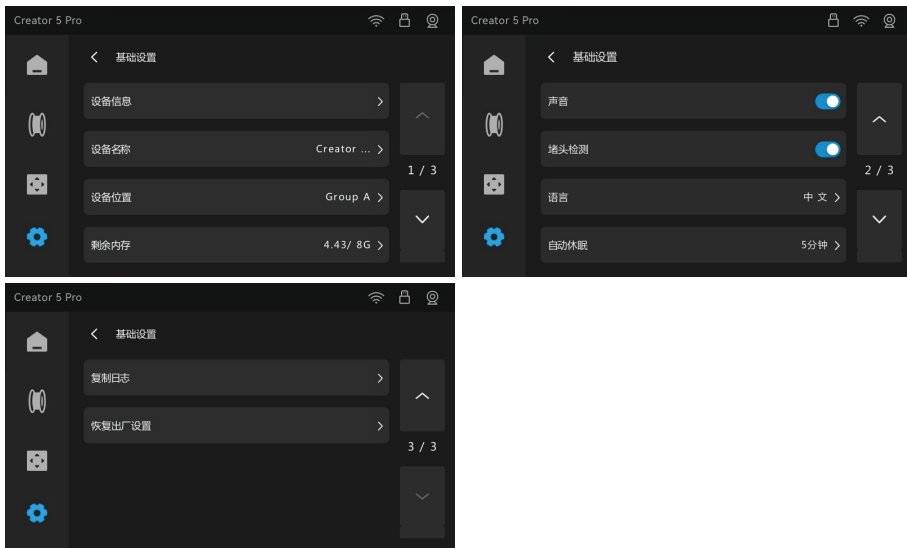

3. 延时视频：延时视频的文件存放管理。

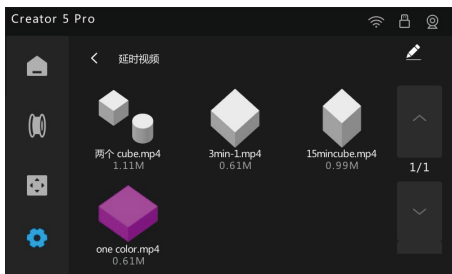

4. 网络：可设置打印机Wi-Fi、IP地址、开启或关闭仅局域网模式。

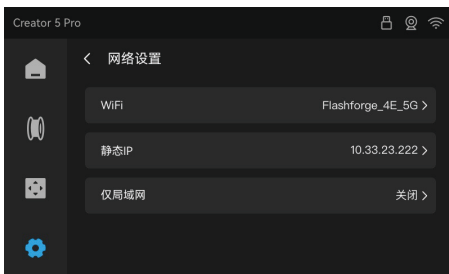

5. 固件：连网时可检测打印机新版本信息，并可在
线更新版本。

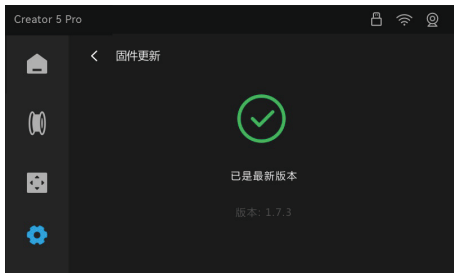

6. 喷头设置：可手动设置喷嘴尺寸信息。



7. 指南与售后

•操作指南：可在线查阅该设备的说明书。

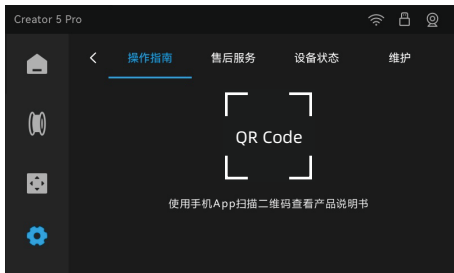

•售后服务：显示闪铸科技售后服务邮箱。

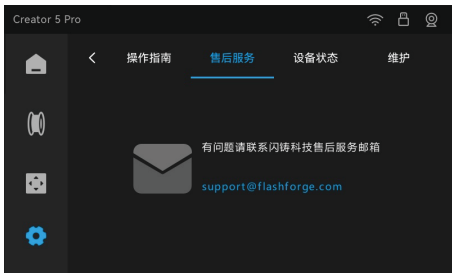

•设备状态：显示打印机各传感器的状态信息。



•维护：设备维护操作指引/提示。



第三章 基础操作介绍

3.1 设备校准

1. 点击【】-【校准】-进入校准界面，可根据需要选择调平、振动补偿、喷头偏移值校准等功能。

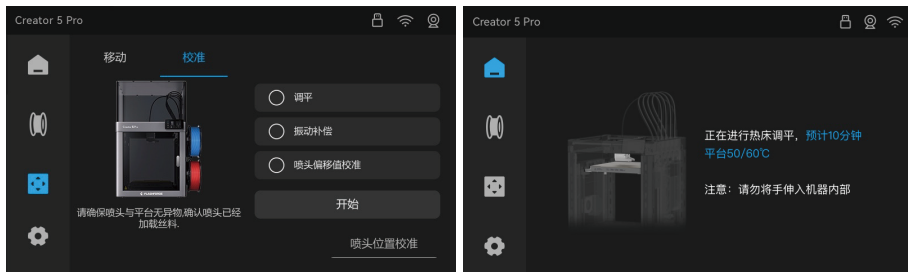

*校准功能说明:

调平: 多点调平自动补偿, 首层打印效果不佳时可执行此操作。调平前确保打印平台上无异物, 且开始后平台会先加热到目标温度, 需要一定的预热等待时间。若使用高温材料打印, 例如ABS、纤维复合材料打印时, 建议打印前勾选调平功能。

振动补偿: 当您发现模型打印完成后表面有振纹或设备发生过搬运的情况下建议进行振动补偿的操作。校准过程中请勿触碰机器, 期间产生的震动及声响均为正常现象。

喷头偏移值校准: 首次使用多喷头同时进行打印任务或更换了喷嘴组件, 建议做一次喷头偏移值校准, 该功能可自动对齐多个工具头之间的XYZ相对位置, 以实现无偏移的高精度打印。开始校准前需要先将打印板取下, 校准完成后放回打印板。

喷头位置校准: 拆装或更换喷头后建议进行喷头位置校准, 用来校准喷头与喷头座的初始位置, 以便喷头座在打印过程中精准抓取对应喷头。选择已更换或拆装的喷头, 并手动将喷头座推动到对应喷头位置并抵住, 机器将识别并进行喷头位置校准。

3.2 网络链接

1. 点击【】-【网络】-打开Wi-Fi开关, 然后选择对应的无线网络进行连接。

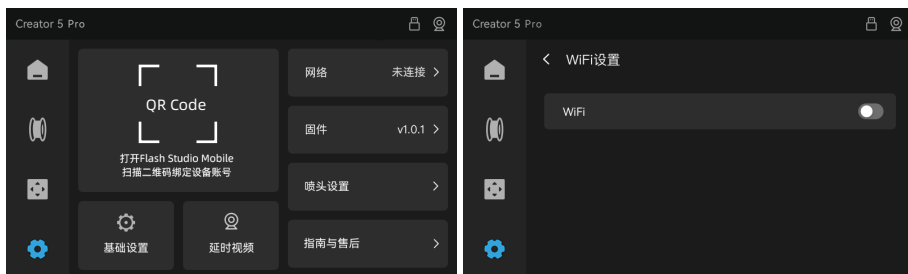

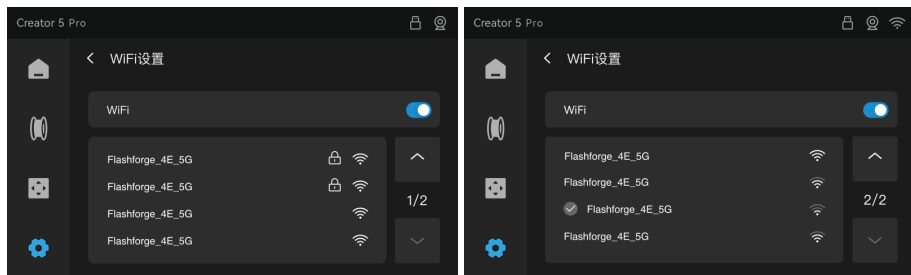

3.3 装载耗材

⚠ 注意事项 装载耗材时请按图示的对应关系悬挂耗材。

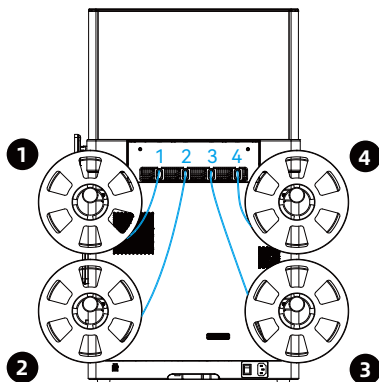

1. 剪去耗材头部弯折部分，将耗材插入进料口，同时按如图所示按压喷头把手，并继续推动，直到耗材完全进入喷头，无法继续推动为止后，松开喷头把手。

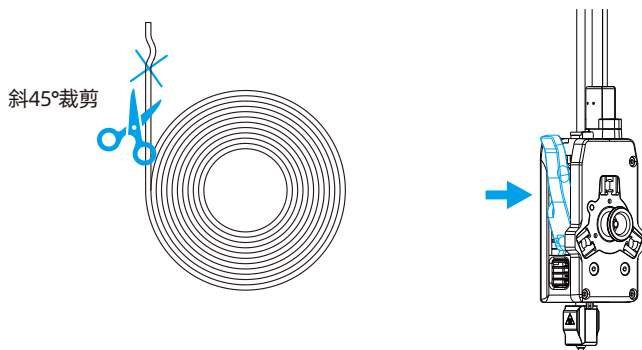

2. 轻轻回拉耗材，如无法拔出，说明已被喷头送丝轮锁住，耗材预装载完成。

3. 在显示屏上点击 ，进入【耗材设置】界面，选中与进料口编号（1-4）对应的喷头位置，点击【编辑】，设置耗材类型与颜色。可重复此步骤设置其他耗材通道。

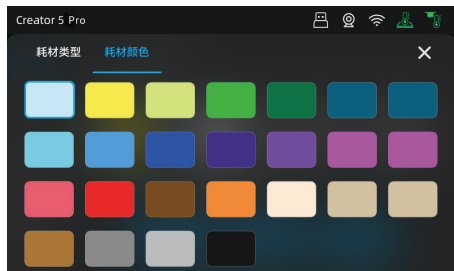
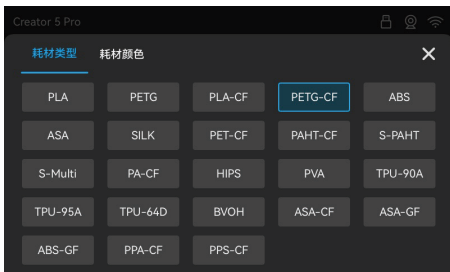

*未完成设置的喷头，状态显示背景为半透明。
材料类型显示“/”为未检测到耗材的状态。
显示“？”为已装载耗材，但未设置耗材类型。

4. 点击【进丝】按钮，观察所选的喷头，当耗材从喷嘴吐出，即进丝成功。

3.4 退出/更换耗材

1. 将喷头取下，按压喷头把手（集成切刀功能）到底，听到耗材切断的声音后，从打印机外侧手动抽出耗材。

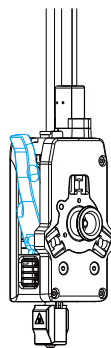

第四章 软件介绍

4.1 APP应用-Flash Studio Mobile

注意：APP绑定打印机需要先将打印机连接网络。

2. 扫码(右图)或通过手机应用商城下载Flash Studio Mobile手机应用,注册您的闪铸账号并登录。



3. 点击主页【⚙️】进入设备设置界面,用Flash Studio Mobile手机应用扫描打印机屏幕上的二维码,将打印机与您的账号绑定。

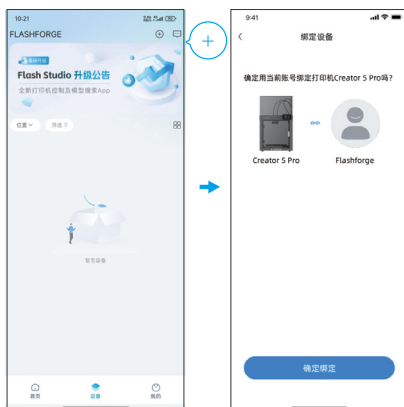

特别提示

1. 设备出厂时默认设备名称为Creator 5 Pro, 位置默认为Group A。
2. 您可以根据实际使用情况在打印机【基础设置】界面修改设备名称和位置。
3. Creator 5 Pro已标配摄像头, 设备开机即默认开启摄像头。您可在App端【设备】页面, 打印机详情页中打开摄像头远程查看实时监控画面。
4. APP不支持仅局域网模式下连接。



4.2 配套切片软件

阅读软件简要说明前，请确认已查看快速启动指南，并已经完成第一次开机打印。

三维模型文件打印前需要先进行对应机器的切片预设才能进行打印。

推荐使用切片软件：**Flash Studio Desktop**。

下载地址：<https://www.flashforge.com/pages/download-center>

操作路径：**software**——**Flash Studio Desktop**

打印前置步骤为：

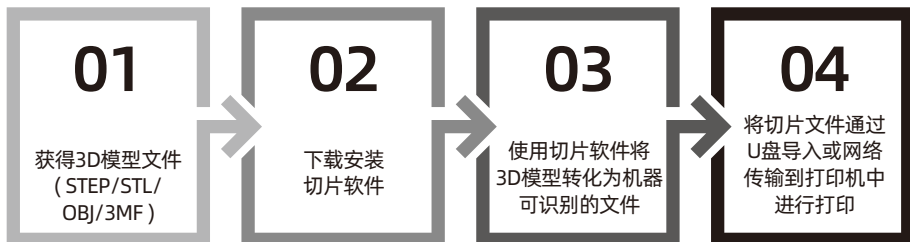

1. 打开安装好的Flash Studio Desktop软件。



Flash Studio Desktop

2. 配置向导

首次使用切片软件时，可根据配置向导的提示依次选择您所在的登录地区、打印机机型和需要的耗材预设。（注：您可以勾选列表中全部的机型及耗材类型，以便后续在切片软件中直接使用对应的打印参数。）

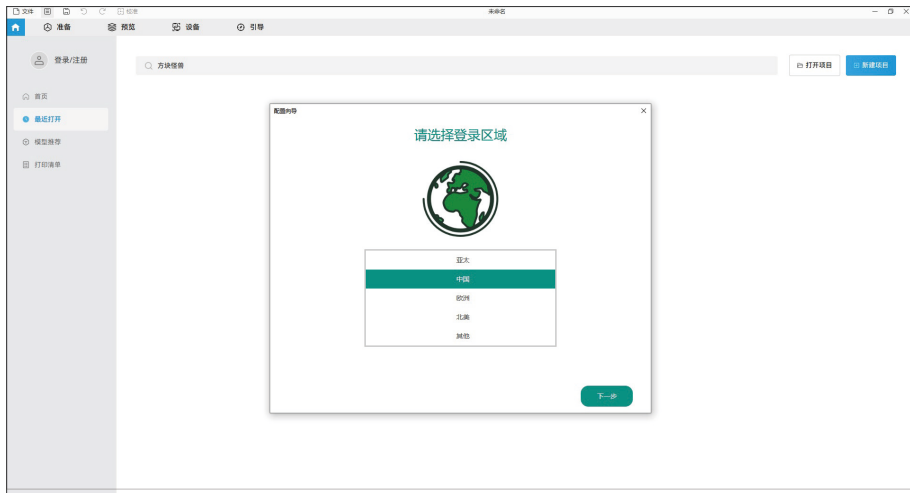

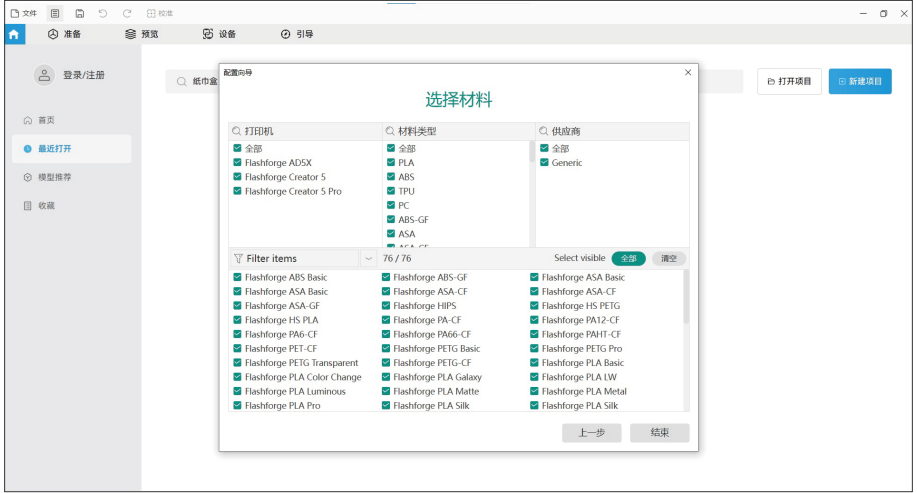
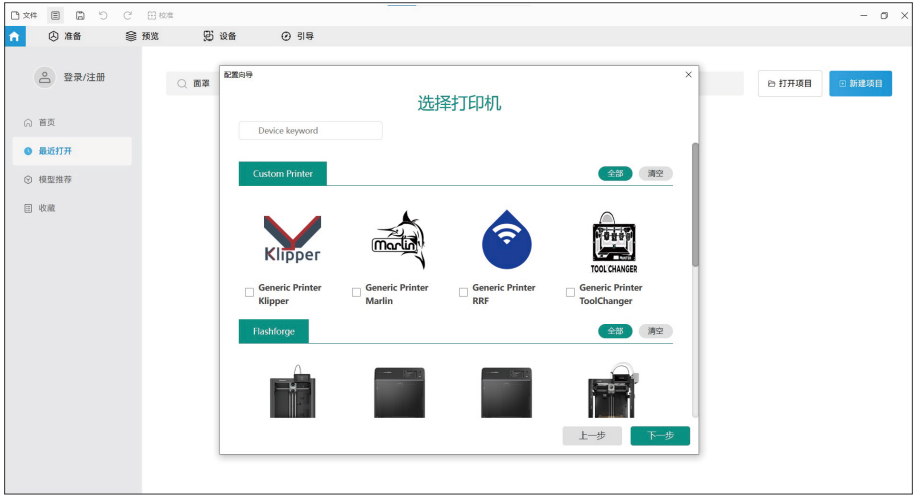

3. 账号登录/注册

使用您的闪铸账号登录Flash Studio Desktop，如果没有账号，可先用手机号或邮箱注册。（注：Flash Studio Desktop 和 Flash Studio Mobile 使用同一账号。）

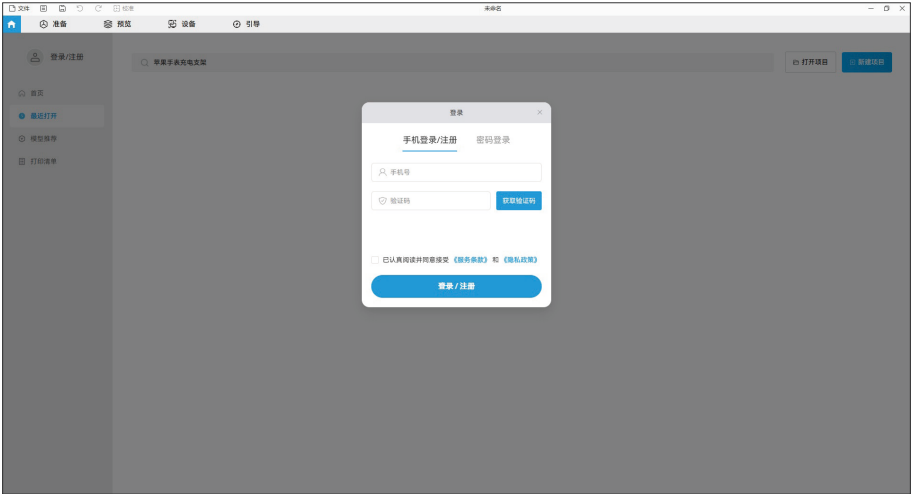

4. 导入或新建模型

在切片软件主页 - 【打开项目】或通过【文件】-【导入】-【导入3MF/STL...】的路径导入您已下载的3D模型，或点击主页【新建项目】，自行在切片软件中创建并编辑想要打印的模型。

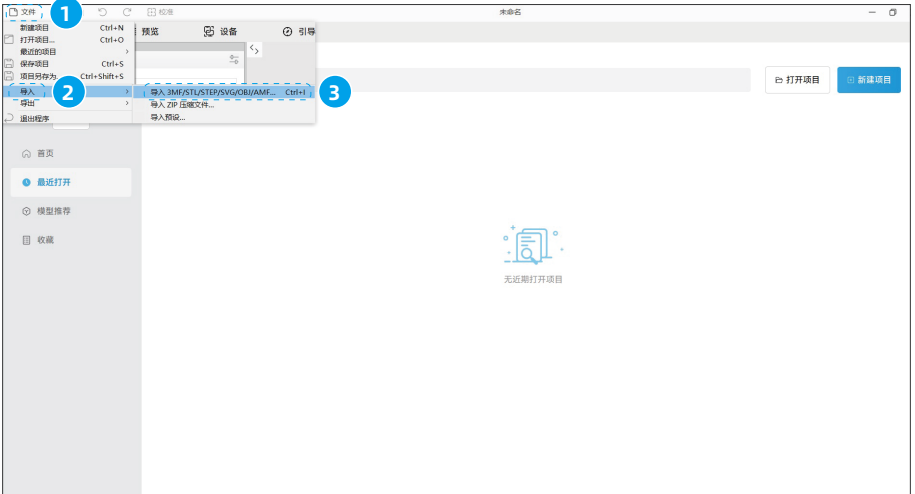

5. 切片前预设/修改

在打印机、耗材丝、工艺的配置栏中可选择对应的打印机机型、热床（即打印板）类型、耗材类型及颜色、打印参数等，在打印区域上方工具栏中可对模型进行移动、旋转、缩放、涂色、添加文字刻印等操作。

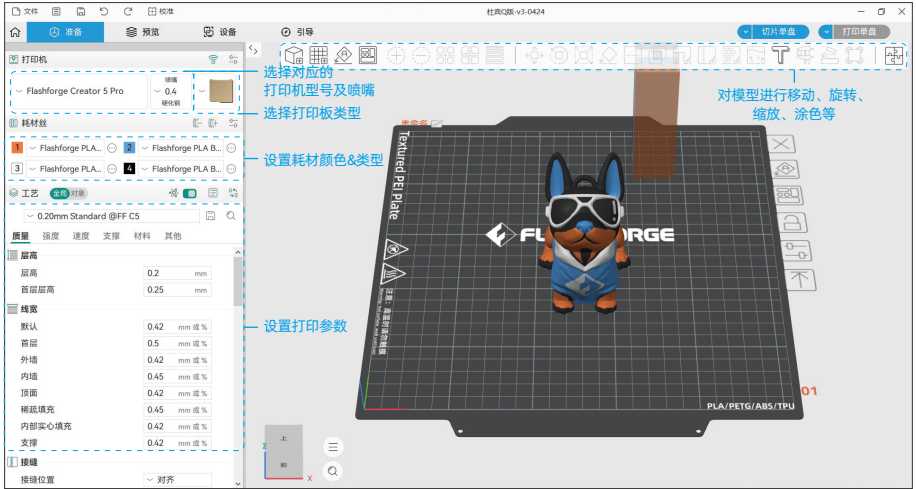

6. 切片模型

点击右上角的【切片单盘/所有盘】，在右侧切片结果中可查看打印所需的耗材克数及打印时间等信息。

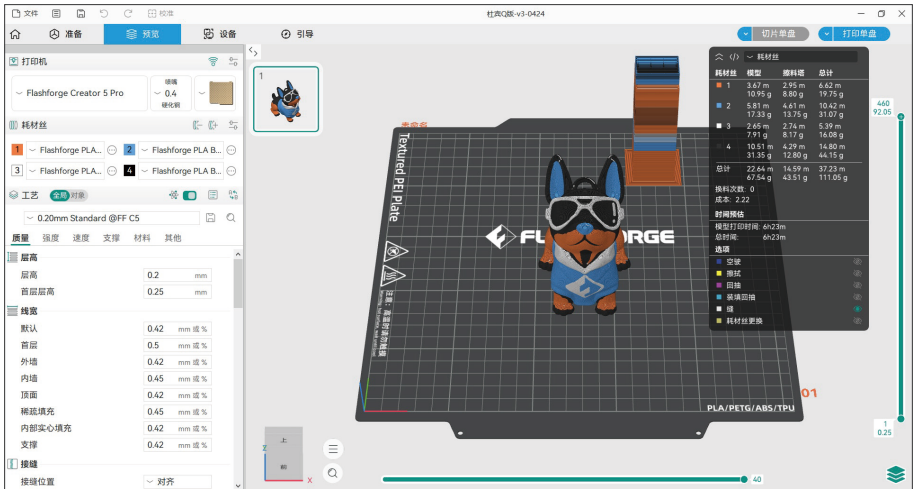

7. 打印模型

切片完成后，点击右上角【打印单盘】，在弹窗中选择对应的打印机，及耗材颜色配置。

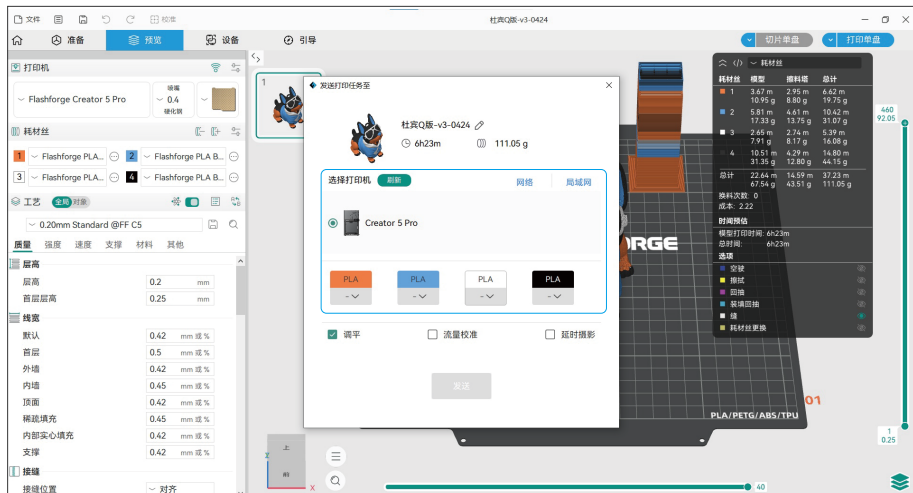

⚠ 注意事项

多色打印时，需要手动配置耗材信息，点击对应喷头，选择对应或相似颜色的耗材（当设备端已经配置好4个喷头的耗材信息后，切片软件可读取到该设备对应喷头的信息。）如图所示。



8. 打印管理/监控

在“设备”页面，您可查看多台打印机设备状态及打印进度情况，点击单个打印机，可进入详情页查看打印详情，并远程控制（暂停/取消打印）或监控打印情况，在喷头与材料中可编辑打印机耗材类型及颜色，会同步刷新到打印机固件页面。

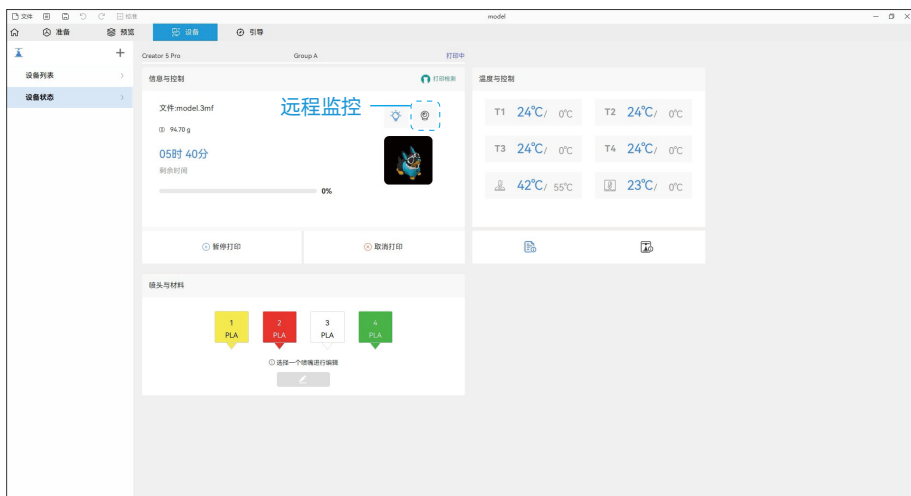
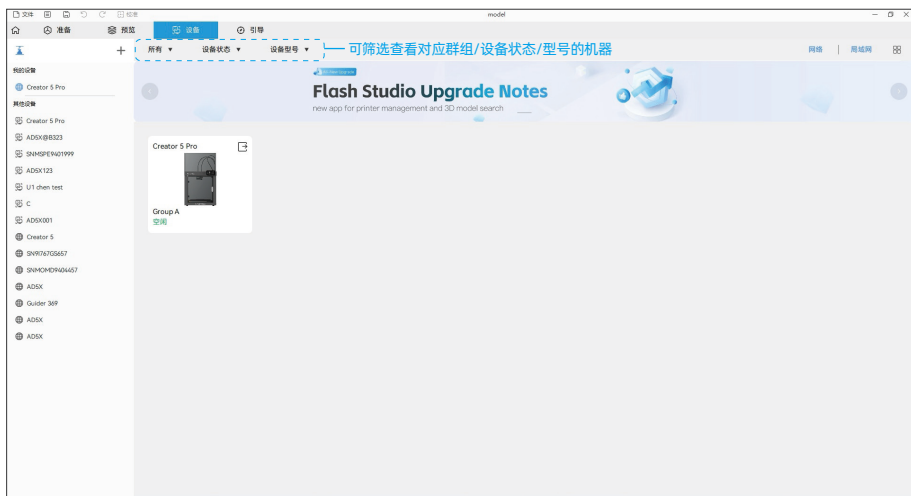

更多软件操作内容，可在切片软件中查看相关功能说明，或在Flashforge官方Wiki查看相关操作指引。
(官网Wiki地址：<https://wiki.flashforge.com/zh/home>)

第五章 打印

5.1 Wi-Fi传输文件打印

远程传输切片文件前需先将打印机连接网络，终端设备连接打印机有两种模式：外网模式与局域网模式。

1. 外网模式下打印机连接前需要先登陆/注册闪铸账号；若手机APP 已经绑定并连接设备，切片软件登陆账户后，则自动显示已连接的设备；若手机APP 未连接绑定，则可以在切片软件的设备页面点击【+】打开搜索列表，选择需要连接的机器。

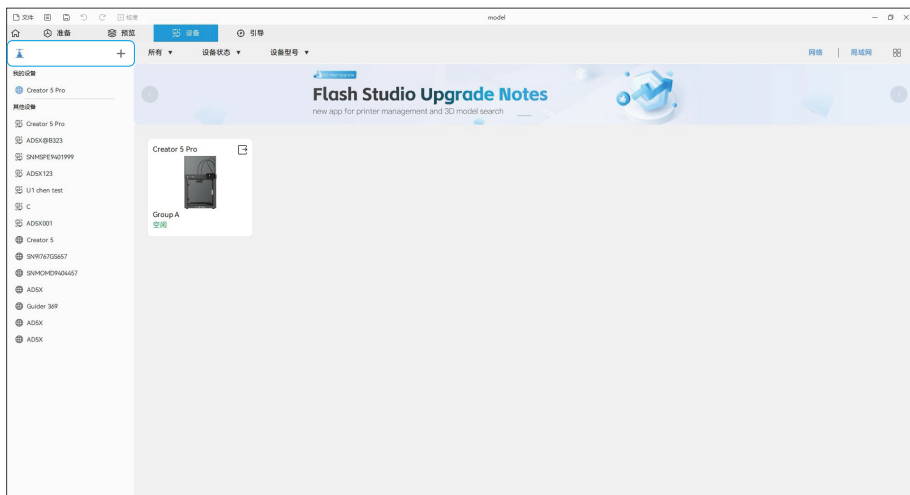

2. 局域网模式下连接打印机需先在设置界面点击【网络】-【仅局域网】，打开仅局域网模式开关。然后切片软件端设备页面点击【+】找到对应打印机。选择相应打印机并输入打印机上的设备识别码完成连接。

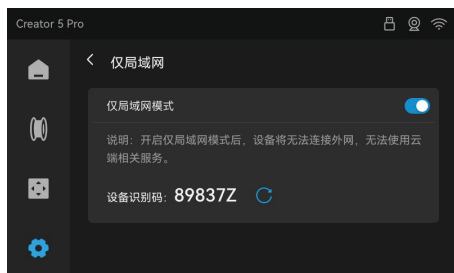

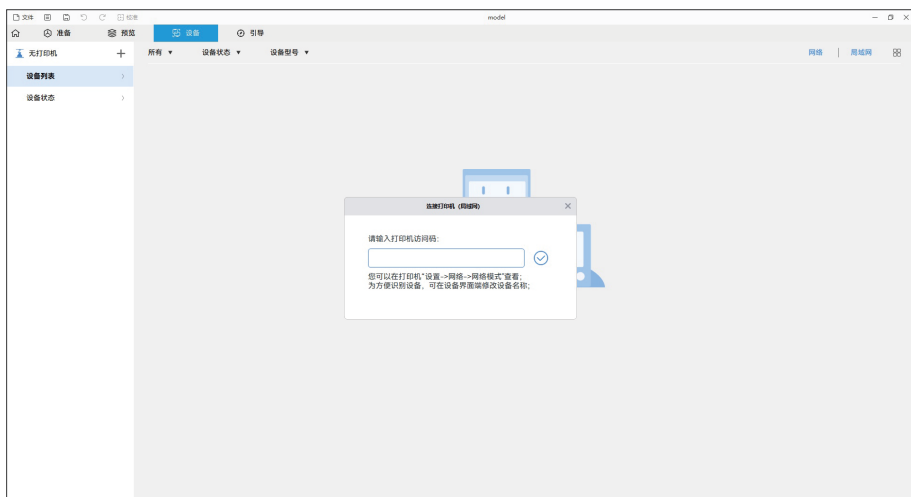
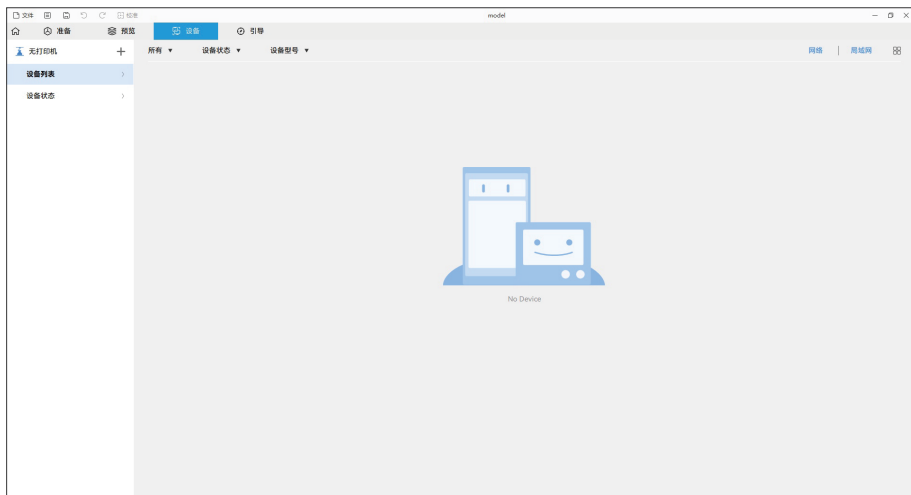

以上两种模式均支持切片远程发送打印任务。

5.2 U盘打印

1. 在切片软件中选择【导出单盘打印文件】（操作路径：文件 - 导出 - 【导出单盘切片文件】），将切片好的文件保存至U盘，默认导出文件格式为3mf 格式。然后将U盘插入设备，选择对应文件打印。



2. 点击【下一步】，用户可手动改变实际所需打印的耗材选项。可以在屏幕上手动选择每个颜色需要对应的喷头，配置完成后，可点击打印。

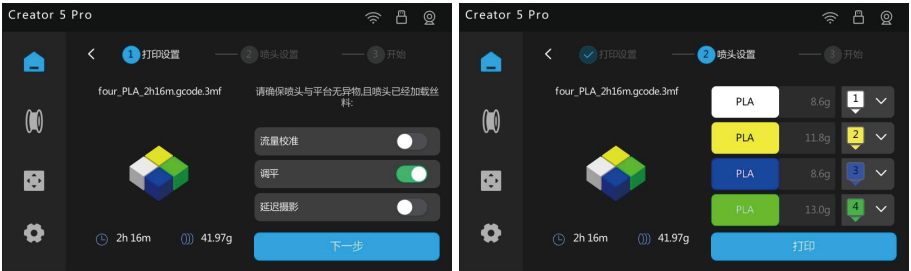

⚠ 注意事项

如上方右图所示，左侧一列为切片软件所配置的耗材类型和颜色；右侧一列为对模型颜色所选择的喷头实际装载的耗材信息（可被重复选择）。如果打印切片时选择的耗材和喷头上装载耗材类型不一致，则无法选择该耗材打印。

5.3 打印后模型移除

⚠ 注意事项

打印完成时，喷嘴和打印平台可能仍处于高温状态，建议冷却后再进行取模型操作！

打印完成后直接取出平台柔性钢板，弯折平台即可取下模型。二次打印时，请确保平台无残余丝料。

模型移除建议：

1. 请将平台板拿到设备外部再进行移除，否则模型碎屑容易留在设备腔体内，建议保持腔体清洁。
2. 建议使用刮刀取下TPU或其他柔性材料打印的模型，使用刮刀进行此操作将确保您可以从面板上剥离柔性模型，而不会对模型造成损坏。

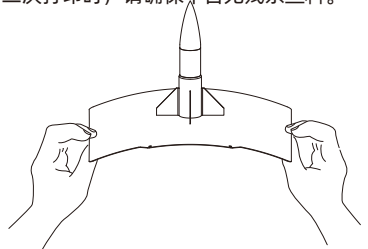

5.4 其他功能设置

1. 使用烘干箱可保持耗材干燥，能有效避免因耗材受潮导致的打印失败或打印质量问题。通过通信线连接VDS（通风循环干燥系统）与打印机，可联机使用，具体操作请参阅VDS使用指南或 Wiki 文档。

2. 断电续打功能。

设备打印过程中遇到断电，待重新开机后，设备将有弹窗提示，是否继续打印，选择是，设备将继续打印未完成的模型。

第六章 维护

6.1 打印平台板使用建议

1. 打印平台板可以配合3D打印专用胶水使用，提高粘附性。
2. 平台板涂胶水后可使用水清洗。
3. 平台板若沾染油污，可使用洗洁精清洗。
4. 避免使用尖锐硬物刮蹭平台板。
5. 平台板若长期使用后有较大形变，建议更换新的平台板。

6.2 喷嘴的使用建议

1. 建议一个喷嘴组件对应同类材料使用。尤其是纤维增强材料与PETG，不可与其他材料混用，若混用材料容易引起堵头，降低喷头使用寿命。
2. 使用同个喷嘴打印不同耗材，更换的耗材打印温度低于当前喷头内耗材的打印温度，需要使用更高温的设置来进行吐丝，进行内部丝料的清洗。
3. 需要更换的耗材打印温度高于当前喷头内耗材的打印温度，直接用新耗材进丝即可。
4. 清洗喷嘴内残余丝料，可多次进丝，或手动通针疏通挤出残留丝料。
5. 更换新的喷嘴组件后，请重新进行调平和喷嘴偏移值校准。

6.3 设备一般维护

1. 打印每累计1000小时，请对设备关键部件进行保养：X轴，Y轴和Z轴的光轴请用无尘布或者无尘纸擦拭干净。
2. Z轴丝杆油污清理干净后请均匀涂抹附带或者可替代的润滑脂。
3. 为了防止耗材受潮断裂在导丝管产生故障，打印机待机超过两天的，请将耗材从机器退出并密封防潮储存。
4. 请及时清理缠绕在丝杆上的丝料或者异物。
5. 维护指南请查看机器维护页面指引（操作路径：[【⚙️】 - 指南与售后-维护](#)）或Flashforge wiki。（官方Wiki网址：<https://wiki.flashforge.com/zh/home>）

6.4 喷嘴更换

更换喷嘴前，请先手动切断耗材。然后按以下步骤操作：
取下图示的两个螺丝，然后捏住硅胶套部位，向下拔出喷嘴组件即可。

⚠️ 注意事项

喷嘴更换后建议执行一次喷头偏移值校准，点击[【🔧】 - 【校准】](#) - 进入校准界面，选择“喷头偏移值校准”，按照指引进行操作。

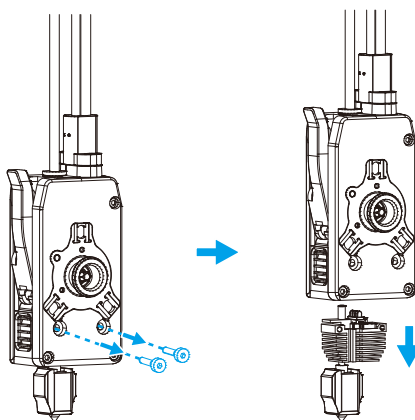

第七章 Q&A

Q1. 喷嘴堵头怎么办？

排查1：手动按压喷头处的把手，切断耗材，然后拔出导丝管，查看耗材头部是否平整。若不是，剪平整后将导丝管与耗材装入喷头，再点击进丝查看。

排查2：拆卸下喷头，查看喷头处耗材是否堵住。

Q2. 点击打印模型，喷头运动，但打印一开始就没有出丝怎么办？

1. 观察导丝管，确认丝料是否已进入喷头，若无，请再点击进丝按钮，直至丝料从喷头中吐出。
2. 查看喷头是否堵头，若是，解决方案请查看Q1。

Q3. 可以使用其他品牌的耗材吗？

可以使用其他品牌耗材，但由于不同材料参数温度略有区别，需要经过参数调整配置。

Q4. 打印模型发生翘边或粘不牢现象怎么办？

方案1：增加平台温度可有效缓解此问题，高温可增加平台与模型的粘附力。

方案2：模型切片时选择添加帽檐（brim）可有效缓解此问题。

方案3：涂抹胶水。

方案4：清洗平台板，去除油污。

方案5：确认平台是否放平。可使用调平校准功能。

Q5. 插入U盘后找不到打印文件，屏幕显示全为文件夹怎么办？

U盘格式不正确，设备支持FAT32格式的文件系统，请将U盘格式化成FAT32格式。

Q6. Wi-Fi连接不上怎么办？

1. 请检查Wi-Fi名称是否含有特殊字符，如果有，请修改之后再次尝试。
2. 请检查密码是否含有特殊字符，如果有，请修改之后再次尝试。

Q7. 更新固件注意事项。

请不要在下载或更新固件时断电断网，防止更新失败。

Q8. 为什么开机屏幕白屏

如果听到开机声音，请更换屏幕或者排线；否则请联系售后人员。

更多内容请查看 Flashforge wiki (<http://wiki.flashforge.com/zh/home>)

第八章 帮助与支持

闪铸专业的售后服务人员及业务员随时为您待命，非常乐意为您解决在您使用过程中遇到的任何问题。如果您无法从用户手册中找到答案，您可以进入我们的官方网站来搜索问题的解决方案，或者通过电话联系我们。

在我们的官网中可以找到一些常见问题的说明和解决方法。您的许多问题都可以在闪铸集团中文官方网站www.sz3dp.com得到解决。操作路径：【技术支持】-【常见问题】-FDM常见问题或查找官方wiki。（<http://wiki.flashforge.com/zh/home>）

您可以在周一到周六上午8:00到下午5:00通过电话来联系闪铸售后团队，为您解决问题。如果您在下班时间联系我们，闪铸将在下一个工作日的第一时间给您反馈。若造成不便，我们万分抱歉。

提示

由于更换不同的丝料，会有少量杂质残留在喷头中造成喷头堵塞，疏通后即可，不属于质量问题。若用户使用时存在该问题，请联系售后，并在售后的指导下完成疏通工作。

售后服务热线：400-886-6023

邮箱：support@flashforge.com

公司地址：浙江省杭州市西湖区文二路328号华星发展大厦B座2-4楼

提示：联系售后时，请提供产品序列号，即打印机背部的条形码



S/N: FFAD*****

规格

2.4G Wi-Fi Frequency Range: 2412MHz~2472MHz (Max EIRP: 15.22dBm)

5.2G Wi-Fi Frequency Range: 5150MHz~5250MHz (Max EIRP: 11.66dBm)

5.8G Wi-Fi Frequency Range: 5725MHz~5850MHz (Max EIRP: 10.91dBm)

该产品可在欧盟成员国使用。

在以下情况下，该设备仅限于在5150MHz~5350MHz WLAN频段运行时在室内使用。

制造商：浙江闪铸集团有限公司

地址：东莞市塘厦镇坚朗路1号2号楼3楼



Follow us

Zhejiang Flashforge 3D Technology Co., Ltd.

Address: Floors 2-4, Building B, Huaxing Development Building,
No.328 Wen'er Road, Xihu District, Hangzhou City, Zhejiang Province, China

Service: support@flashforge.com

Suggestions and Complaints: mkt2@flashforge.com

Web: flashforge.com | enterprise.flashforge.com

浙江闪铸集团有限公司

地址：浙江省杭州市西湖区文二路328号华星发展大厦B座2-4楼

服务热线：400 8866 023

建议与投诉：mkt2@flashforge.com

网址：www.sz3dp.com